

3D*labs*[®]

GLINT[®] 500TX[™]

Hardware Reference Manual

Issue 4

The material in this document is the intellectual property of 3Dlabs. It is provided solely for information. You may not reproduce this document in whole or in part by any means. While every care has been taken in the preparation of this document, 3Dlabs accepts no liability for any consequences of its use. Our products are under continual improvement and we reserve the right to change their specification without notice.

3Dlabs products and technology are protected by a number of worldwide patents. Unlicensed use of any information contained herein may infringe one or more of these patents and may violate the appropriate patent laws and conventions.

3Dlabs is the worldwide trading name of 3Dlabs Inc. Ltd.

3Dlabs and GLINT are registered trademarks and PERMEDIA is a trademark of 3Dlabs Inc. Ltd.

Microsoft, Windows and Direct3D are either registered trademarks or trademarks of Microsoft Corp. in the United States and/or other countries. OpenGL is a registered trademark of Silicon Graphics, Inc. Macintosh and Power Macintosh are registered trademarks and QuickDraw is a trademark of Apple Computer Inc. All other trademarks are acknowledged and recognized.

© Copyright 3Dlabs Inc. Ltd. 1997. All rights reserved worldwide.

3Dlabs Inc.
181 Metro Drive, Suite 520
San Jose, CA 95110
United States
Tel: (408) 436 3455
Fax: (408) 436 3458

3Dlabs Ltd.
Meadlake Place
Thorpe Lea Road. Egham
Surrey, TW20 8HE
United Kingdom
Tel: +44 (0) 1784 470555
Fax: +44 (0) 1784 470699
Email: info@3dlabs.com
Web: <http://www.3dlabs.com>

Change History

Document	Issue	Date	Change
106.1.56	1	29 April 96	First Release
	2	14 May 96	Updates to Chapters 3, 4, 5, 8, 9, 10, 11, 12 and Appendix A added.
	3	4 June 96	
	4	5 Mar 97	Typing corrections to sections 3.2.1, 4.2.16, 7.3, 9.2, 9.3, 9.3.1, 9.8, 11.5.1, A.1. Style change. Index added.

Contents

1. GLINT 500TX Functional Overview	1
1.1 Introduction	1
1.2 Notation.....	1
1.3 GLINT 500TX Graphics Core	2
1.4 PCI Interface	2
1.5 Big-endian Processor Support	2
1.6 Localbuffer Memory Interface	2
1.7 Framebuffer Memory Interface.....	3
1.8 Shared Framebuffer/Shared Localbuffer Interface	3
1.9 Video Timing Generation	3
1.10 External Video Logic Interface.....	4
1.11 Reset Configuration Control	4
1.12 Expansion EPROM support	4
1.13 GLINT 500TX Address Map	4
2. PCI Configuration Region	5
2.1 Device Identification.....	6
2.2 Device Control	8
2.3 Device Status	9
2.4 Miscellaneous Functions.....	10
2.5 Base 12	
2.6 Expansion ROM Interface.....	16
3. Region 0 - Control Registers.....	17
3.1 Region 0 Address Map	17
3.2 Localbuffer Registers	31
3.3 Framebuffer Registers.....	35
3.4 Graphics Core Registers	42
3.5 Graphics Core FIFO Interface.....	43
4. Internal Video Timing Generator.....	44
4.1 Overview of Internal VTG features.....	44
4.2 Internal VTG Register Set	45
4.3 VTG Configuration	54
4.4 VRAM Serial Port Control	57
4.5 VTG Example	62
5. External Video Control Registers.....	64
5.1 External Video Interface Signal Definitions.....	64
5.2 LUT-DAC Interface.	65
5.3 Resetting External Circuitry	65
6. Localbuffer.....	66
6.1 Configurations - DRAM Types.	66

6.2 PCI Region 1 and Region 3 Address Map	67
6.3 Localbuffer Memory Types	67
6.4 Localbuffer Example Configuration	69
6.5 Shared Localbuffer	69
7. Framebuffer.....	70
7.1 Configurations - VRAM Types and Features.....	70
7.2 PCI Region 2 and Region 4 Address Map	71
7.3 Shared Framebuffer/Shared Memory Interface.	73
7.4 Framebuffer Timing.....	76
7.5 VRAM Requirements.....	76
7.6 External Timing Generator.....	76
7.7 Framebuffer Configurations	78
8. GLINT 500TX Register Set.....	80
9. Electrical Data.....	83
9.1 Absolute Minimum/Maximum Ratings.....	83
9.2 DC Specifications	83
9.3 AC Specifications.....	84
10. Pin Information.	105
10.1 Package Pinout.....	105
10.2 Pin Descriptions.....	106
10.3 Pin Lists.....	110
11. Thermal Management	116
11.1 Device Characteristics	116
11.2 Thermal Model.....	116
11.3 Operation Without Heatsink.....	116
11.4 Operation With Heatsink.....	117
11.5 Heatsink Attachment.....	118
12. Reset Control and Test Mode.....	119
12.1 Reset	119
12.2 Clock Operation at Reset.....	119
12.3 Reset Localbuffer Configuration	119
12.4 Reset Framebuffer Configuration.....	121
12.5 Production Test Mode	124
13. Package Dimensions	125
App. A GLINT 300SX and 500TX Hardware Differences	126
Index	129

Tables

Table 1-1.	Localbuffer DRAM Types.....	3
Table 1-2.	Maximum Pixel Clock Support	4
Table 1-3.	PCI Address Regions.....	4
Table 2-1.	Configuration Region.	5
Table 2-2.	Expansion ROM Connections.....	16
Table 4.1.	Options For Serial Port Control	57
Table 5-1.	External Video Signals	64
Table 6-1.	Localbuffer Sizes With 4Mbit Technology Memories.....	66
Table 6-2.	Localbuffer Sizes With 16Mbit Technology Memories.....	66
Table 6-3.	Localbuffer Field Sizes.	67
Table 6-4.	Localbuffer Visible Bypass Memory.....	67
Table 7-1.	Framebuffer Configurations	70
Table 7-2.	Framebuffer Pixel Packing.....	71
Table 7-3.	Framebuffer Visible Bypass Memory	71
Table 7-4.	Shared Memory Configuration.....	73
Table 7-5.	Primary Controller Signals	74
Table 7-6.	Secondary Controller Signals.....	74
Table 7-7.	Timing Generator Pins	78
Table 7-8.	Framebuffer Addressing in Dual-CAS Mode.....	79
Table 8-1.	GLINT 500TX Configuration Region Registers	80
Table 8-2.	GLINT 500TX Region 0 Registers.....	81
Table 9-1.	Absolute Minimum/Maximum Ratings	83
Table 9-2.	DC Specifications.....	83
Table 9-3.	PCI Signal DC Specifications.....	83
Table 9-4.	Non PCI Signal DC Specifications	84
Table 9-5.	Test Loads For AC Timing	84
Table 9-6.	Clock Waveform Timing	85
Table 9-7.	PCIClk Referenced Input Timing	86
Table 9-8.	PCIClk Referenced Output Timing	87
Table 9-9.	MClk Referenced Input Timing.....	88
Table 9-10.	MClk Referenced Output Timing.....	89
Table 9-11.	VClk Referenced Input Timing.....	90
Table 9-12.	VClk Referenced Output Timing.....	91
Table 9-13.	Framebuffer Timing	94
Table 9-14.	VRAM Access Time Requirements.....	96
Table 9-15.	Localbuffer Timing - Fast-page mode	98
Table 9-16.	Localbuffer Access Time Requirements - Fast Page Mode.....	99
Table 9-17.	Localbuffer Timing - EDO mode.....	101
Table 9-18.	Localbuffer Access Time Requirements - EDO Mode.	102
Table 9-19.	ROM Read Timings.....	102
Table 9-20.	ROM Access Times.....	103
Table 9-21.	LUT-DAC Timings.....	104
Table 9-22.	LUT-DAC Access Times.	104
Table 10-1.	Pin Descriptions	106

Table 10-2. Alphabetical Pin Listing	110
Table 10-3. Numerical Pin Listing.....	112
Table 11-1. 304 pin CQFP Package Thermal Characteristics	117
Table 12-1. GLINT 500TX Functional Mode	124
Table 12-2. GLINT 500TX Board ATE Mode	124
Table 13-1. 304 pin CQFP Package Dimensions.....	125
Table A-1. Shared Framebuffer and Localbuffer Options.....	126
Table A-2. Extended Pin Functionality	128

Figures

Figure 1-1	GLINT 500TX Functional Units.....	1
Figure 2-1	Expansion ROM interface.....	16
Figure 3-1.	Region 0 Address Map.....	17
Figure 4-1.	Video Timing Generator.....	44
Figure 4-2.	Horizontal Timing.....	54
Figure 4-3.	Vertical Timing.....	55
Figure 4.4	Serial Control of 1-Way interleaved Display.....	58
Figure 4.5	2-Way Or 4-Way interleaved Serial Port With 64bit RAMDAC.....	59
Figure 4.6	2-Way Interleaved With TX Enhanced = 1 , SOE Ctl = 0.	60
Figure 4.7	2-Way Interleaved With TX Enhanced = 1 , SOE Ctl = 1.	60
Figure 4.8	4-Way interleaved Serial Port.	61
Figure 5-1	Typical LUT-DAC Interface.....	65
Figure 6-1	8MByte Localbuffer (32 bit wide)	69
Figure 7-1	Packed Write to Buffer A.....	72
Figure 7-2	Packed Write to Buffer B.....	72
Figure 7-3	Packed Write to Buffer A and Buffer B.....	72
Figure 7-4.	Shared Framebuffer Control Signals	74
Figure 7-5	External Timing Generator Interface	77
Figure 7-6	Transfer Request Protocol.....	78
Figure 9-1	Clock Waveform Timing	85
Figure 9-2	PCIClk Referenced Input Timing	86
Figure 9-3	PCIClk Referenced Output Timing	87
Figure 9-4	MClk Referenced Input Timing.....	88
Figure 9-5	MClk Referenced Output Timing.....	89
Figure 9-6	VClk Referenced Input Timing.....	90
Figure 9-7	VClk Referenced Output Timing.....	91
Figure 9-8	Framebuffer Read Timings.....	92
Figure 9-9	Framebuffer Write Timing.....	92
Figure 9-10	Framebuffer Transfer Cycle Timing	93
Figure 9-11	Framebuffer CAS-Before-RAS Refresh Timings.....	93
Figure 9-12	Localbuffer Read Timings - Fast-Page Mode.....	96
Figure 9-13	Localbuffer Write Timings - Fast-Page Mode.....	97
Figure 9-14	Localbuffer CAS-Before-RAS Refresh Timings	97
Figure 9-15	Localbuffer Write Timings - EDO mode.....	99
Figure 9-16	Localbuffer Read Timings - EDO mode	100
Figure 9-17	ROM Read Timings.....	102
Figure 9-18	LUT-DAC Read Timings	103
Figure 9-19	LUT-DAC Write Timings.....	103
Figure 10-1	GLINT 500TX Pin Numbering.....	109
Figure 13-1	Mechanical Diagrams.....	125

1. GLINT 500TX Functional Overview

1.1 Introduction

The GLINT 500TX high performance graphics processor combines workstation class 3D graphics acceleration and state of the art 2D performance in a single chip. All 3D rendering operations are accelerated by the GLINT 500TX, including Gouraud shading, texture mapping, depth buffering, antialiasing and alpha blending.

Implemented around a scaleable memory architecture, the GLINT 500TX reduces the cost and complexity of delivering high performance 3D graphics within a windowing environment - making it ideal for a wide range of graphics products from PC boards to high end workstation accelerators.

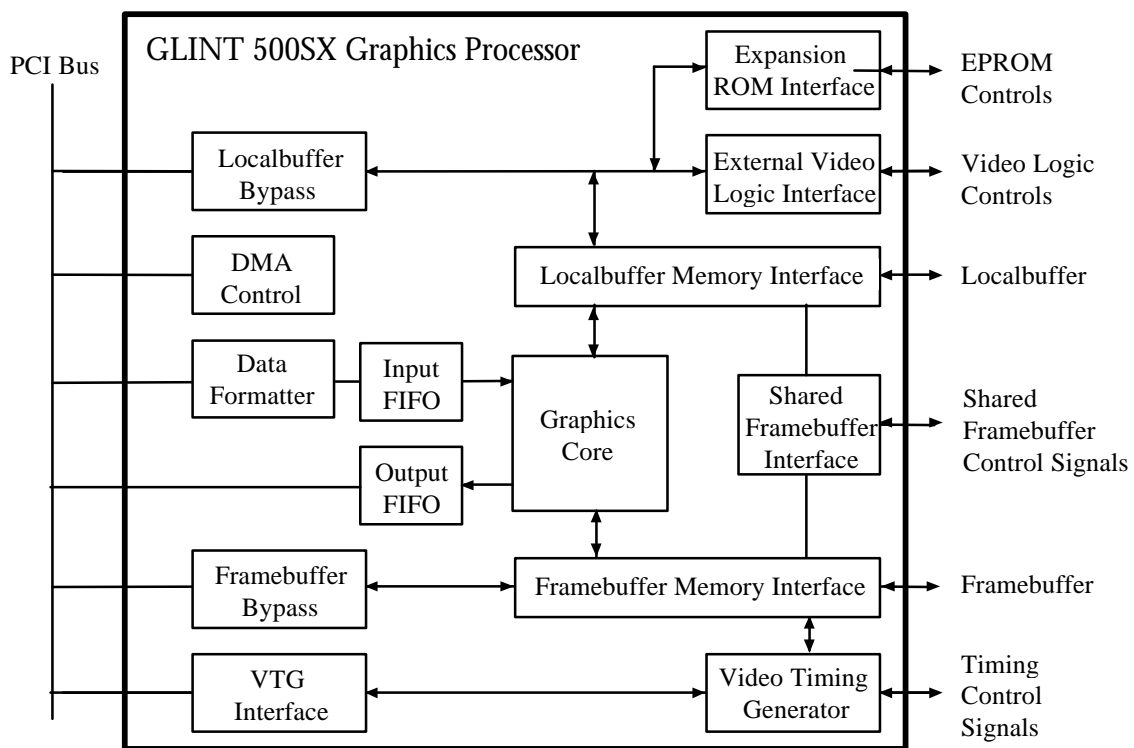

Figure 1-1 GLINT 500TX Functional Units

1.2 Notation

The following notational conventions are used in this book.

A signal name ending in N indicates an active low signal, e.g. PCIFrameN.

n-m indicates a bit field from bit n to bit m, e.g. 7-0 specifies bits 7 through 0 inclusive.

Use of the letter h indicates a hexadecimal number, e.g. 6Fh is a hexadecimal number.

Use of the letter b indicates a binary number, e.g. 1010b is a binary number.

Use of the letter X indicates that a value is undefined, e.g. XXXh is a undefined hexadecimal number.

1.3 GLINT 500TX Graphics Core

The Graphics Core (GC) in the GLINT 500TX accelerates the key operations for 3D and 2D applications. For further information on the functionality of the GC refer to the GLINT 500TX Programmers Reference Manual.

1.4 PCI Interface

The PCI interface conforms to the PCI Local Bus standard Revision 2.1. The GLINT 500TX is a PCI Local Bus Target and a PCI Local Bus Read Master.

The host interface includes the configuration registers, the GLINT 500TX control registers, and two bypass paths: one to the Localbuffer memory and one to the Framebuffer memory.

The PCI interface has an input FIFO for passing data to the Graphics Core, and an output FIFO for buffering up data to be read from the Graphics Core. The input FIFO is 32 words deep. The output FIFO is 8 words deep.

A DMA controller is provided in the PCI interface to allow the GLINT 500TX to read data directly into the Graphics Core input FIFO.

1.5 Big-endian Processor Support

The GLINT 500TX provides support for big-endian processors. A big-endian processor will generate byte swapped big-endian data on the PCI local bus, commonly known as gib-endian.

All the regions on the GLINT 500TX can accept gib-endian data. The configuration space is set by a control pin at reset time and the GLINT 500TX control registers are always visible little and gib-endian.

The Localbuffer and Framebuffer each have two PCI apertures whose endian is programmable.

1.6 Localbuffer Memory Interface

The Localbuffer memory is used to store off screen pixel associated information. This includes Depth (Z), Stencil, and texture data.

The Localbuffer consists of one or two banks of DRAM giving from 2 to 48 Mbytes of storage. A Localbuffer width of 0 to 48 bits is supported. The number of bits populated in any hardware implementation will depend on software requirements. The memory control signals are programmable to allow for optimum operation at different GLINT 500TX clock speeds with memory systems using -50 to -80 speed DRAM parts. Page sizes from 256 to 2048 are supported. EDO DRAM is also supported.

The Localbuffer interface provides a link to the PCI Local Bus to allow host accesses to bypass the Graphics Core.

Table 1-1. Localbuffer DRAM Types

DRAM Generic types
256K x 16/18
512k x8/9
1M x 4
1M x 16/18
2M x 8/9
4M x 4

DRAMs used must support fast page-mode or Extended-DataOut and CAS-BEFORE-RAS refresh.

1.7 Framebuffer Memory Interface

The GLINT 500TX can address a Framebuffer of between 2MByte and 32MBytes of VRAM. A Framebuffer data width of 64 bits is supported. The VRAMs supported include 256kx4, 256kx8 and 256kx16. The VRAMs must support split transfer cycles.

The memory control signals are programmable to allow for optimum operation at different GLINT 500TX clock speeds with a range of memory speeds allowing -60 to -80 VRAMs to be used. The GLINT 500TX can make use of VRAM write masks and block fill mode, if available, to improve performance.

LUT-DACs with 64 and 128 bit pixel buses are supported. For more information on LUT-DAC support refer to External Video Control (Section 5).

GLINT 500TX interfaces directly to most Framebuffers, however Framebuffers with greater than 16 memory parts require external buffering of the address and control lines.

The Framebuffer interface also provides a link to the PCI Local Bus to allow host accesses to bypass the Graphics Core.

The GLINT 500TX supports 32, 16, and 8 bit packed framestores.

1.8 Shared Framebuffer/Shared Localbuffer Interface

The GLINT 500TX provides a mechanism to share the Framebuffer and/or the Localbuffer with another device. The GLINT 500TX can be programmed to either perform the sharing arbitration (primary controller) or act as a slave (secondary controller).

1.9 Video Timing Generation

The GLINT 500TX has an internal timing generator and VRAM transfer controller for simple Framebuffer configurations. For more complex configurations an external timing generator and transfer controller is required.

The maximum video clock (VClk) for the GLINT 500TX is 80MHz. The video clock is derived from the video output pixel clock. The pixel clock is divided by the number of serial port interleaved banks. So if the pixel clock is 135MHz and there are 4 serial port interleaved banks, the video clock to the GLINT 500TX will be clocked at 33.75MHz.

Maximum GLINT 500TX video clock rates (assuming 50MHz VRAMs) are shown in table 1-2.

Table 1-2. Maximum Pixel Clock Support

Pixel Width	Serial Interleave	Maximum Pixel Frequency
32 bit	4	200MHz
16 bit	8	400MHz
8 bit	16	800MHz

1.10 External Video Logic Interface

The GLINT 500TX can control external video logic such as the video output LUT-DAC. The address and data lines for the control come from the Localbuffer interface. Control signals are provided to allow standard LUT-DACs to be connected directly to the GLINT 500TX. Some LUT-DACs will require a small amount of glue logic.

1.11 Reset Configuration Control

A number of parameters for the GLINT 500TX are set at reset time, such as Localbuffer and Framebuffer memory size and speed. The reset state is configured with resistors connected to the Localbuffer data pins. The state of the data pins is sampled on the rising edge of the reset line. See Reset Control (Section 12) for more details.

1.12 Expansion EPROM support

The GLINT 500TX supports an expansion EPROM. This EPROM may store code needed for device-specific initialization and expansion of the boot time code.

1.13 GLINT 500TX Address Map

The GLINT 500TX has six PCI base address regions:

Table 1-3. PCI Address Regions

Region	Description
Configuration	PCI configuration region
0	GC control region
1	Aperture 0 access to Localbuffer memory
2	Aperture 0 access to Framebuffer memory
3	Aperture 1 access to Localbuffer memory
4	Aperture 1 access to Framebuffer memory
ROM	Expansion ROM

2. PCI Configuration Region

The PCI Configuration Region provides a set of 'hooks' which satisfies the needs of current and anticipated system configuration mechanisms. The configuration registers are accessed and modified by the use of Configuration Read and Write commands.

Sixty four bytes of the Configuration registers are predefined within the PCI Specification and are supported by the GLINT 500TX. The remaining 192 Bytes are device specific and are unused by the GLINT 500TX.

Table 2-1. Configuration Region.

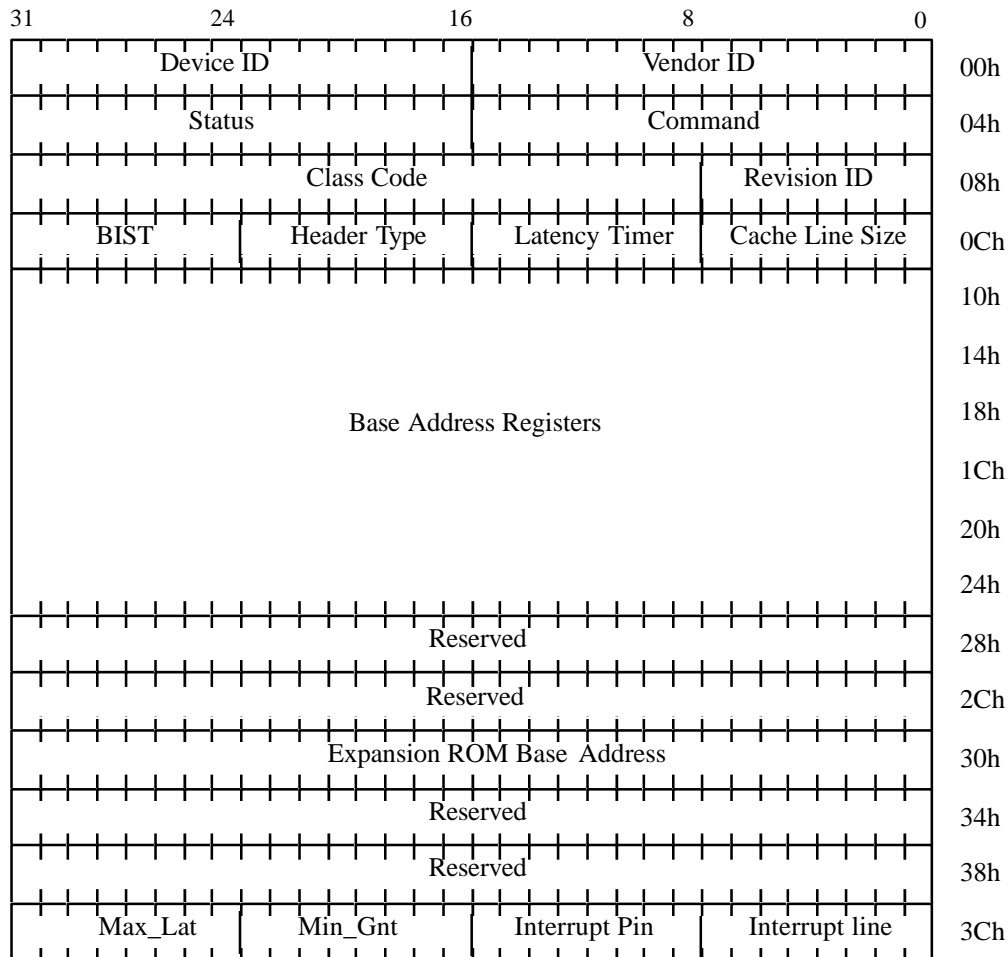

2.1 Device Identification

2.1.1 Vendor ID

Vendor identification number.

CFGVendorId

Region: Config Offset: 00h
 Read Only Reset Value: 3D3D

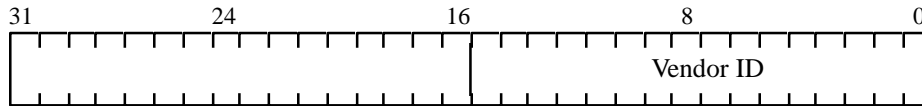

Bits 15-0 3D3Dh
 3Dlabs company code

2.1.2 Device ID

Device identification number.

CFGDeviceId

Region: Config Offset: 02h
 Read Only Reset Value: 0002h

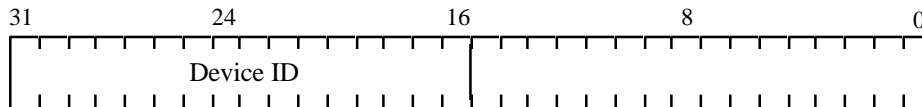

Bits 31-16 0002h
 GLINT 500TX Device number

2.1.3 Revision ID

Revision identification number.

CFGRevisionId

Region: Config Offset: 08h
 Read Only Reset Value: Revision Number

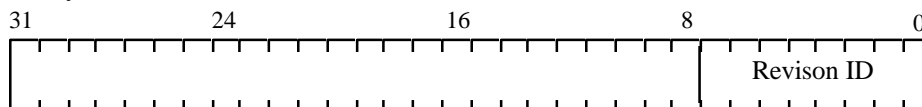

The revision ID register returns the following code:

Bits 7 - 0 Revision
 01h = Revision R01

2.1.4 Class Code Register

CFGClassCode

Region: Config Offset: 09h
 Read Only Reset Value: 038000h

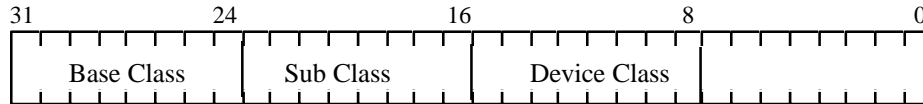

Bits 31-24 03h
 Base class. PCI Definition: Display controller

Bits 23-16 80h
 Sub class. PCI Definition: Other Display controller (not VGA or XGA)

Bits 15-8 00h
 Device class

NB. Some operating systems may expect a device of Class 03h 80h to contain a VGA device and fail to boot correctly if no VGA device is present. The GLINT 500TX has no in-built VGA and hence this problem may occur. To avoid this problem setting the 'Base Class Zero' field of the FBMemControl register using a configuration resistor causes the Class Code register to return 00h 00h (Backward Compatibility Class). - see section 3.3.1

2.1.5 Header Type

CFGHeaderType

Region: Config Offset: 0Eh
 Read Only Reset Value: 00h

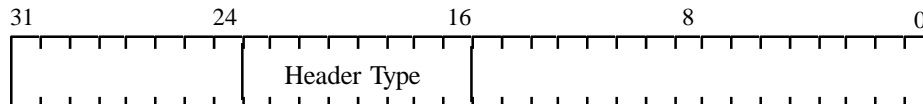

Bits 23-16 00h
 Header Type. PCI Definition: Single function device

2.2 Device Control

2.2.1 Command Register

The command register provides control over a device’s ability to generate and respond to PCI cycles. Writing zero to this register disconnects the device from the PCI for all except configuration accesses. All necessary bits within the command register are supported for the functionality contained in the GLINT 500TX.

CFGCommand

Region: Config Offset: 04h
 Read/Write Reset Value: 0000h

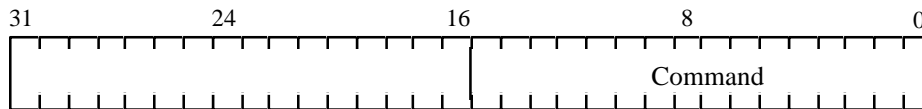

- Bit 0 I/O access enable (Read Only)
 0 = The GLINT 500TX has no I/O space regions
- Bit 1 Memory access enable
 0 = Disable memory space accesses. (RESET)
 1 = Enable memory space accesses
- Bit 2 Master enable
 0 = Disable master accesses. (RESET)
 1 = Enable master accesses
- Bit 3 Special Cycle access enable (Read Only)
 0 = The GLINT 500TX never responds to special cycle accesses.
- Bit 4 Memory Write and Invalidate enable (Read Only)
 0 = The GLINT 500TX master never issues Memory Write and Invalidate accesses.
- Bit 5 VGA palette snoop enable (Read Only)
 0 = The GLINT 500TX is not a VGA device.
- Bit 6 Parity error report enable (Read Only)
 0 = The GLINT 500TX does not report parity errors.
- Bit 7 Address/Data stepping enable (Read Only)
 0 = The GLINT 500TX does not do stepping.
- Bit 8 SERR driver enable(Read Only)
 0 = The GLINT 500TX does not report parity errors.
- Bit 9 Master Fast back-to-back enable (Read Only)
 0 = The GLINT 500TX master does not implement fast back-to-back accesses.
- Bits 15-10 Reserved
 000000b

2.3 Device Status

2.3.1 Status Register

The Status Register is used to record status information for PCI related events. The definition for each bit is given below.

Reads to this register behave normally. Writes function differently in that bits can be reset but not set. A bit is reset whenever the register is written and the data in the corresponding bit location is a 1.

CFGStatus

Region: Config Offset: 06h

Read Only Reset Value: 00h

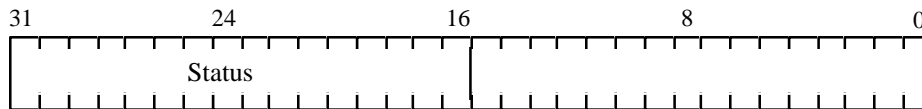

Bits 22-16 Reserved (Read Only)
0000000b.

Bit 23 Fast back-to-back Transactions (Read Only)
1 = Indicates support for fast back-to-back PCI transactions .

Bit 24 Master Parity check flag (Read Only)
0 = Parity checking not implemented on the GLINT 500TX.

Bits 26-25 10b (Read Only)
Indicates that the GLINT 500TX asserts DevselN at medium speed.

Bit 27 Target Abort flag (Read Only)
0 = The GLINT 500TX never issues a target abort.

Bit 28 Master Target Abort flag
Set by master when transaction terminates with target abort.

Bit 29 Master Abort flag
Set by master when it terminates transaction with master abort.

Bit 30 SERR flag (Read Only)
0 = Parity checking not implemented on the GLINT 500TX.

Bit 31 PERR flag (Read Only)
0 = Parity checking not implemented on the GLINT 500TX.

2.4 Miscellaneous Functions

2.4.1 BIST

Optional register used for control and status of BIST.

CFGBist

Region: Config Offset: 0Fh

Read Only Reset Value: 00h

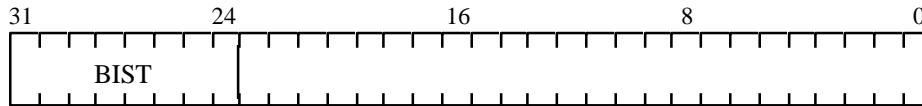

Bits 31-24 BIST

00h. BIST unsupported by the GLINT 500TX over the PCI interface.

2.4.2 Latency Timer

This register specifies, in PCI bus clocks, the value of the Latency Timer for this PCI bus master.

CFGLatTimer

Region: Config Offset: 0Dh

Read/Write Reset Value: 00h

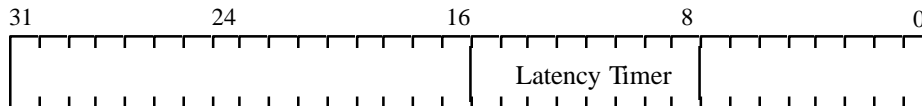

Bits 15-8 Latency Timer Count

Sets the maximum number of PCI clock cycles for master burst accesses.

2.4.3 Cache Line Size

This register specifies the cache line size in units of 32 bit words. It is only implemented for masters which use the 'Memory write and invalidate' command. The GLINT 500TX does not use this command.

CFGCacheLine

Region: Config Offset: 0Ch

Read Only Reset Value: 00h



Bits 7-0 Cache Line Size

00h. Cache line size unsupported.

2.4.4 Maximum Latency

This register specifies how often the PCI device needs to gain access to the PCI bus.

CFGMaxLat

Region: Config Offset: 3Fh

Read Only Reset Value: Determined by Localbuffer data pins

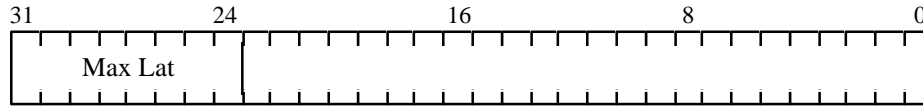

Bits 31-24 Maximum Latency

LB Reset Bits 21-20

Set by the reset value of Localbuffer data pins.
Possible values are: 00h, 40h, 80h, and C0h.

2.4.5 Minimum Grant

This register specifies the duration of a burst period required by the PCI device.

CFGMinGrant

Region: Config Offset: 3Eh

Read Only Reset Value: Determined by Localbuffer data pins

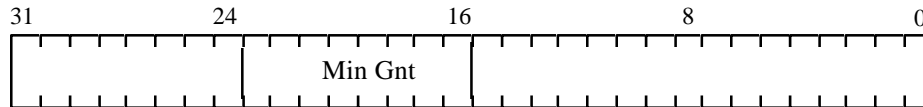

Bits 23-16 Minimum Grant

LB Reset Bits 23-22

Set by the reset value of Localbuffer data pins.
Possible values are: 00h, 40h, 80h, and C0h.

2.4.6 Interrupt Pin

The Interrupt Pin register tells the BIOS which interrupt line is used by the GLINT 500TX.

CFGIntPin

Region: Config Offset: 3Dh

Read Only Reset Value: 01h

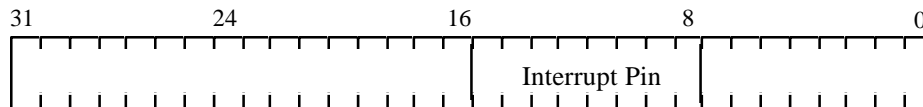

Bits 15-8 Interrupt Pin

01h The GLINT 500TX uses Interrupt pin A

2.4.7 Interrupt Line

The Interrupt Line register is an 8 bit register used to communicate interrupt line routing information.

CFGIntLine

Region: Config Offset: 3Ch

Read/Write Reset Value: 00h

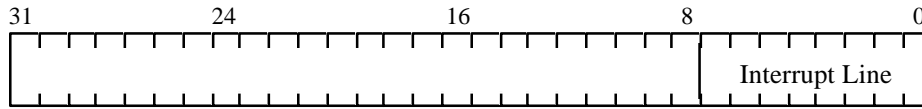

Bits 7-0 Interrupt Line

2.5 Base

The base address registers allow the boot software to relocate PCI devices in the address spaces. At system power-up device independent software must be able to determine what devices are present, build a consistent address map, and determine if a device has an expansion ROM.

2.5.1 Base Address 0 Register

The Base Address 0 Register contains the GLINT 500TX control space offset. The control registers are in memory space. They are not prefetchable and can be located anywhere in 32 bit address space.

CFGBaseAddr0

Region: Config Offset: 10h

Read/Write Reset Value: 0000.0000h

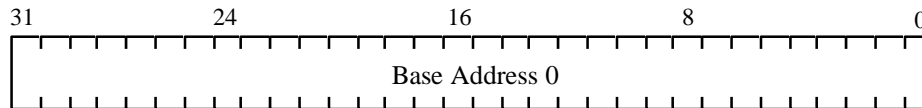

Bits 31-17 Base offset
Loaded at boot time to set offset of the control register space.

Bits 16-4 Size indication Read Only
000h Indicates that the control registers must be mapped into 128KBytes.

Bits 3-0 Address Type Read Only
0h Memory Space, not prefetchable, in 32 bit address space

2.5.2 Base Address 1 Register

The Base Address 1 Register contains the GLINT 500TX aperture 0 Localbuffer offset. The Localbuffer is in memory space. It is not prefetchable and can be located anywhere in 32 bit address space.

CFGBaseAddr1

Region: Config Offset: 14h
Read/Write Reset Value: 0000.0000h

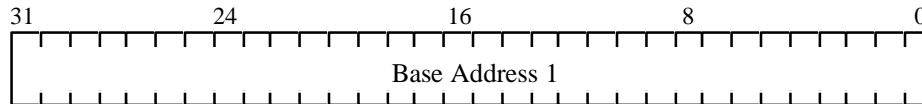

Bits 31-xx	Base offset		
	Loaded at boot time to set offset of the Localbuffer space.		
Bits xx-4	Size indication	Read Only	LB Reset Bits 26-24
	0000h Set at reset time by the Localbuffer data pins.		
	The following sizes are possible: 0M, 1M, 2M, 4M, 8M, 16M, 32M, and 64M Bytes.		
Bits 3-0	Address Type	Read Only	
	0h Memory Space, not prefetchable, in 32 bit address space		

2.5.3 Base Address 2 Register

The Base Address 1 register contains the GLINT 500TX aperture 0 Framebuffer offset. The Framebuffer is in memory space. It is not prefetchable and can be located anywhere in 32 bit address space.

CFGBaseAddr2

Region: Config Offset: 18h
Read/Write Reset Value: 0000.0000h

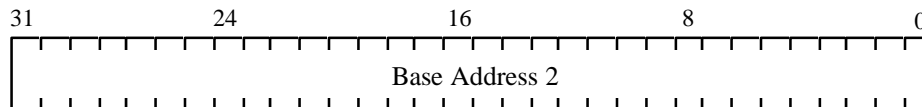

Bits 31-xx	Base offset		
	Loaded at boot time to set offset of the Framebuffer space.		
Bits xx-4	Size indication	Read Only	FB Reset Bits 31-29
	0000h Set at reset time by the Framebuffer data pins.		
	The following sizes are possible: 0M, 1M, 2M, 4M, 8M, 16M, and 32M Bytes.		
Bits 3-0	Address Type	Read Only	
	0h Memory Space, not prefetchable, in 32 bit address space.		

2.5.6 Expansion ROM Base Address

The Expansion ROM Base register is the offset address for the expansion ROM. The ROM is in memory space.

CFGRomAddr

Region: Config Offset: 30h
 Read/Write Reset Value: 0000.0000h

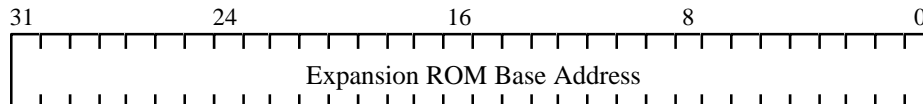

Bits 31-16	Base offset Loaded at boot time to set offset of the Expansion ROM.	
Bits 15-11	Size indication 00h Indicates that the Expansion ROM must be mapped into 64KBytes.	Read Only
Bits 10-1	Reserved 000h PCI reserved register bits.	Read Only
Bit 0	Access enable 0 = Expansion ROM accesses disabled 1 = Expansion ROM accesses enabled	

2.6 Expansion ROM Interface

A 64K x 8 bit interface is provided for an expansion ROM. This interface is read only from the PCI. The address and data lines share pins with the Localbuffer data bus as defined in table 2-2.

Table 2-2. Expansion ROM Connections

Signal	Pins used	Description
RomAddr(15-0)	LBMemData(39-24)	Expansion ROM Address lines.
RomData(7-0)	LBMemData(47-40)	Expansion ROM Data bus.
RomEnN	RomEnN	Expansion ROM read strobe (negative active)

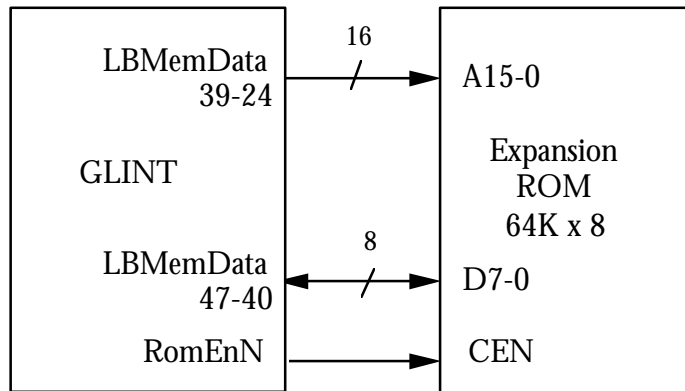

Figure 2-1 Expansion ROM interface

3. Region 0 - Control Registers

3.1 Region 0 Address Map

The GLINT 500TX region 0 is a 128KByte region containing the control registers and ports to and from the Graphics Core.

The control space is mapped in twice in the 128KByte region. In the second 64K the registers are mapped to be byte swapped for big endian hosts.

Offset	Function	Byte Swap Offset
0000.0000h	Control Status Registers	0001.0000h
-		-
0000.0FFFh	Localbuffer Registers	0001.0FFFh
0000.1000h		0001.1000h
-	Framebuffer Registers	-
0000.17FFh		0001.17FFh
0000.1800h	GC FIFO Interface	0001.1800h
-		-
0000.1FFFh	Internal Video Registers	0001.1FFFh
0000.2000h		0001.2000h
-	External Video Registers	-
0000.2FFFh		0001.2FFFh
0000.3000h	GC Register Access (Through FIFO)	0001.3000h
-		-
0000.3FFFh	GC Register Access (Through FIFO)	0001.3FFFh
0000.3000h		0001.3000h
-	GC Register Access (Through FIFO)	-
0000.7FFFh		0001.7FFFh
0000.8000h	GC Register Access (Through FIFO)	0001.8000h
-		-
0000.FFFFh	GC Register Access (Through FIFO)	0001.FFFFh

Figure 3-1. Region 0 Address Map

3.1.1 Reset Status Register

Writing to the reset status register forces a software reset of the GLINT 500TX Graphics Core. The software reset does not reset the PCI interface. It is provided for software diagnostics in case an incorrect register set up locks up the internal GC.

The software reset takes a number of cycles and the GC must not be used during the reset. A flag in the register is provided which shows that the software reset is still in progress.

For more information on the operation of the GLINT 500TX at reset please refer to Reset Control (Section 12).

ResetStatus

Region: 0 Offset: 0000.0000h

Read/Write Reset Value: 0000.0000h

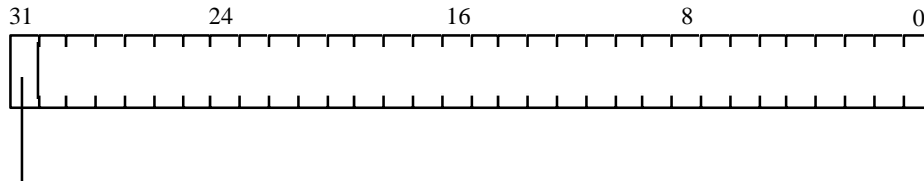

Software Reset Flag

Bits 30-0 Reserved

Bit 31 Software Reset Flag

0 = The GLINT 500TX is ready for use

1 = The GLINT 500TX is being reset and must not be used

3.1.2 Interrupt Enable Register

The Interrupt Enable Register allows for a number of GLINT 500TX flags to generate a PCI interrupt. Five interrupt sources are defined below. At reset all interrupts sources are disabled.

IntEnable

Region: 0 Offset: 0000.0008h

Read/Write Reset Value: 0000.0000h

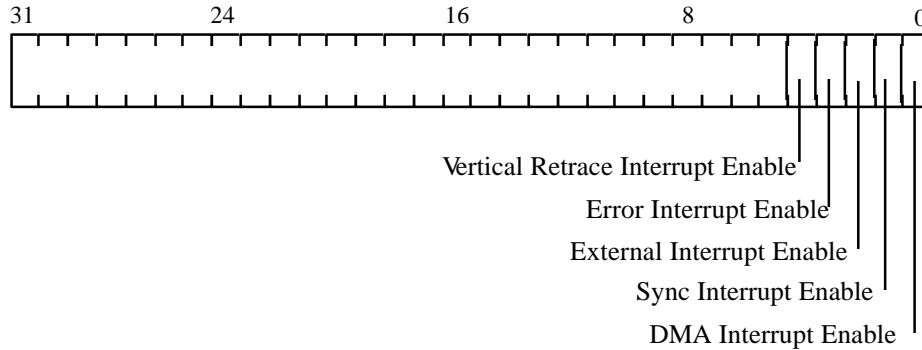

Bit 0	DMA interrupt enable 0 = Disable interrupt (RESET) 1 = Enable interrupt
Bit 1	Sync interrupt enable 0 = Disable interrupt (RESET) 1 = Enable interrupt
Bit 2	External interrupt enable 0 = Disable interrupt (RESET) 1 = Enable interrupt
Bit 3	Error interrupt enable 0 = Disable interrupt (RESET) 1 = Enable interrupt
Bit 4	Vertical retrace interrupt enable 0 = Disable interrupt (RESET) 1 = Enable interrupt

3.1.3 Interrupt Flags Register

The Interrupt Flags Register shows which interrupts are outstanding on the GLINT 500TX.

Flag bits are reset by writing to this register with the corresponding bit set to a 1. Flags at positions where the bits are set to 0 will be unaffected by the write.

IntFlags

Region: 0 Offset: 0000.0010h

Read/Write Reset Value: 0000.0000h

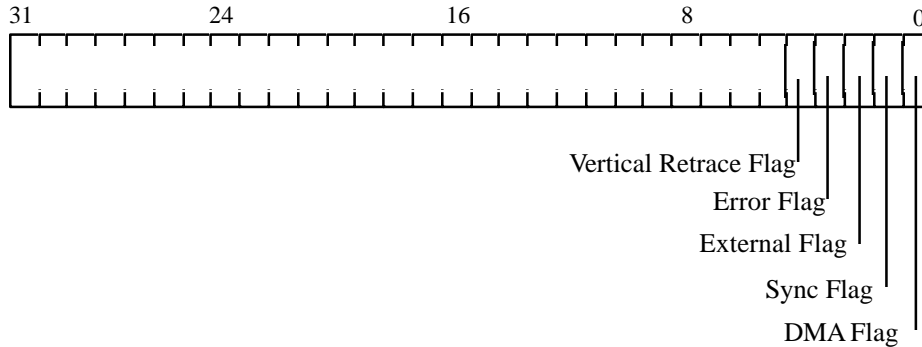

- Bit 0 DMA Flag
 0 = No interrupt (RESET)
 1 = Interrupt outstanding
- Bit 1 Sync Flag
 0 = No interrupt (RESET)
 1 = Interrupt outstanding
- Bit 2 External Flag
 0 = No interrupt (RESET)
 1 = Interrupt outstanding
- Bit 3 Error Flag
 0 = No interrupt (RESET)
 1 = Interrupt outstanding
- Bit 4 Vertical Retrace Flag
 0 = No interrupt (RESET)
 1 = Interrupt outstanding

3.1.4 Input FIFO Space Register

The input FIFO space register indicates the number of words that can currently be written to the input FIFO. This register can be read at any time and used to allow the controlling software to efficiently send data to the GLINT 500TX. If the DMA controller for the FIFO is in use, the value read is a snapshot of the current FIFO status.

InFIFOspace

Region: 0 Offset: 0000.0018h

Read Only Reset Value: 0000.0010h

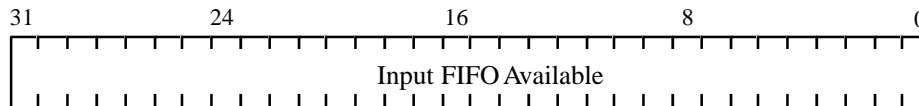

Bits 31-0 Input FIFO Space

Valid range: 0 to 16.

The number of empty words in the input FIFO. This number of words can be written before checking again for FIFO space availability. Although the input FIFO is 32 words deep, the maximum Input FIFO space returned is 16 for compatibility with GLINT 300SX.

3.1.5 Output FIFO Words Register

The output FIFO words register indicates the number of words currently in the output FIFO. This register can be read at any time and used to allow the controlling software to efficiently read output data from the GLINT 500TX.

OutFIFOWords

Region: .0 Offset: 0000.0020h

Read Only Reset Value: 0000.0000h

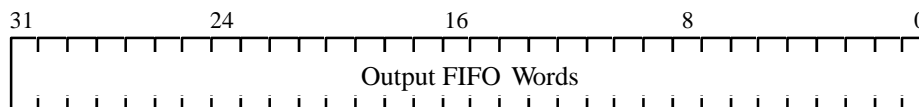

Bits 31-0 Output FIFO Words

Valid range: 0 to 8.

The number of valid words in the output FIFO. This number of words can be read before checking for more words.

3.1.6 DMA Start Address

The DMA address should be loaded with the first PCI address for the buffer to be transferred to the GC when using the DMA controller.

Writing to the DMA start address register loads the address into the DMA address counter. Once a DMA has been set off the next DMA start address may be loaded. A read of this register returns the last start value loaded even if the DMA is underway.

DMAAddress

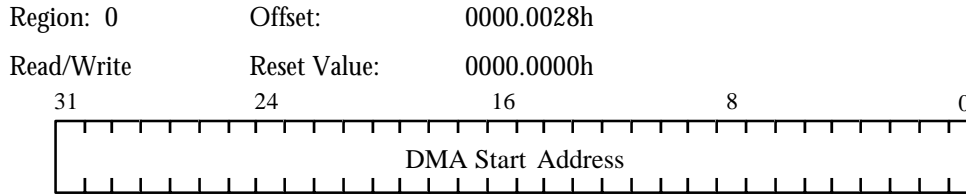

Bits 31-0 DMA Start Address
 PCI start address for PCI master read transfer to the Graphics Core.

3.1.7 DMA Count

The DMA count register should be loaded with the number of words to be transferred in the DMA operation. The action of loading a word count greater than zero sets off the DMA operation. The value read back from this register indicates the current number of words left to be transferred.

This register should only be written to if the count is zero. It can be read at any time.

DMACount

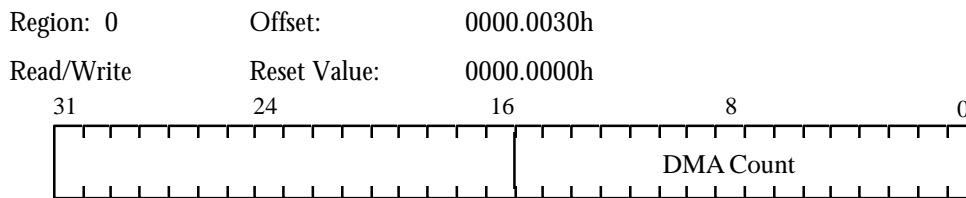

Bits 15-0 DMA Count
 Valid Range: 0 to 65535
 Number of words to be transferred in DMA operation.
 Undefined action if this register is written to when it is not zero.

3.1.8 Error Flags Register

The Error Flags Register shows which errors are outstanding on the GLINT 500TX.

Flag bits are reset by writing to this register with the corresponding bit set to a 1. Flags at positions where the bits are set to 0 will be unaffected by the write.

ErrorFlags

Region: 0 Offset: 0000.0038h

Read/Write Reset Value: 0000.0000h

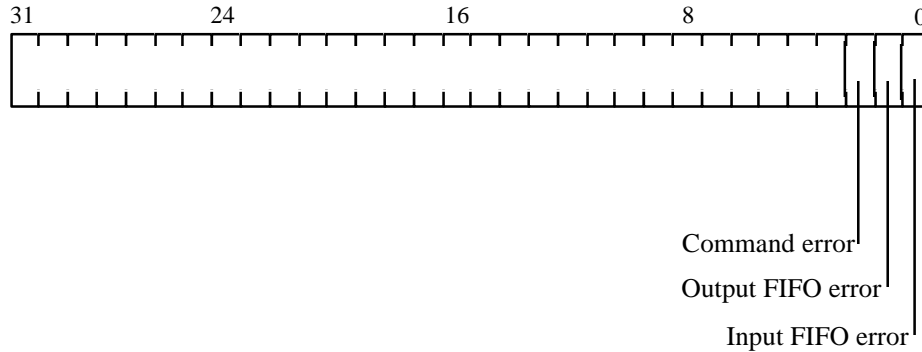

- Bit 0 Input FIFO Error Flag
 Flag set on write to full input FIFO
 0 = No error (RESET)
 1 = Error outstanding
- Bit 1 Output FIFO Error Flag
 Flag set on read from empty output FIFO
 0 = No error (RESET)
 1 = Error outstanding
- Bit 2 Command Error Flag
 Flag set on incorrect mixing of accesses to the input FIFO space and the GC register space
 0 = No error (RESET)
 1 = Error outstanding

3.1.9 Video Clock Control Register

The video clock control Register drives two physical pins on the GLINT 500TX. These pins are used to program the video clock PLL chip.

VClkCtl

Region: 0 Offset: 0000.0040h

Read/Write Reset Value: 0000.0000h

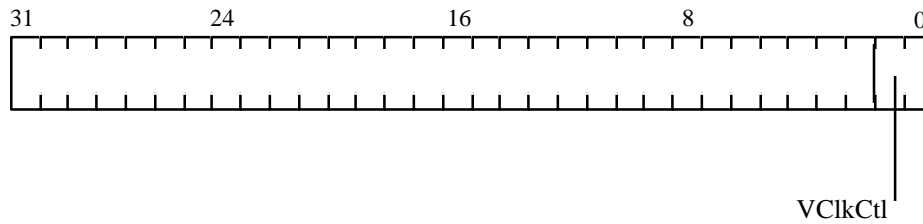

Bit 0 VClkCtl (0)

Bit 1 VClkCtl (1)

3.1.10 Test Register

The test register is not to be used by any user software. Writes to this register have an undefined effect.

The GLINT 500TX powers up in functional mode.

TestRegister

Region: 0 Offset: 0000.0048h

Read/Write Reset Value: 0000.0000h

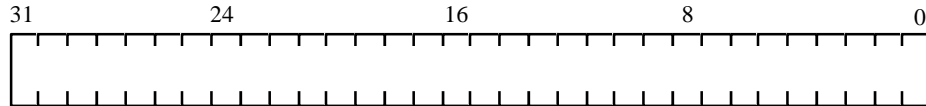

Bit 0	Rasterizer
Bit 1	Scissor Stipple
Bit 2	Color DDA
Bit 3	Fog
Bit 4	Alpha test
Bit 5	LB read
Bit 6	GID Stencil Depth
Bit 7	LB write
Bit 8	FB read
Bit 9	Alpha blend
Bit 10	Dither
Bit 11	Logicops
Bit 12	FB Write
Bit 13	Host out
Bit 14	Texture Address
Bit 15	Texture Read
Bit 16	Texture Color
Bit 17	Router

3.1.11 Aperture 0 Control Register

The aperture 0 control Register sets up the data transfer modes for the Localbuffer visible in region 1 and the Framebuffer in region 2.

The Localbuffer can be set to be byte swapped for big endian hosts.

The Framebuffer can be set to be byte swapped and half word swapped for big endian hosts.

The Framebuffer can be used in a mode whereby two 16-bit buffers (A and B) are interleaved together on a per-pixel basis. Each 32bit word contains a 16 bit pixel from buffer A and the equivalent pixel from buffer B. Control bits are provided to allow reading and writing of Buffers A and B as contiguous 16-bit packed buffers, despite their being pixel-interleaved within memory. Each 32-bit read or write access over the PCI bus thus transfers two 16-bit pixels to either Buffer A or Buffer B as selected by the fields below.

Aperture0

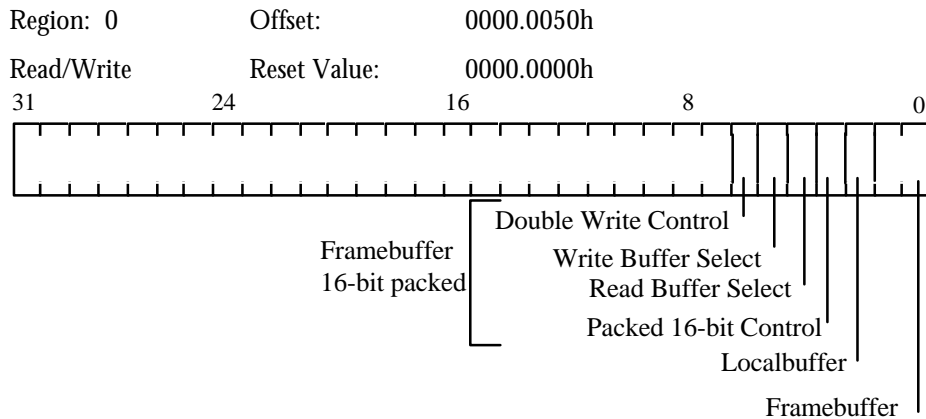

- Bits 1-0 Framebuffer Byte Control
 - 0 = Standard
 - 1 = Byte Swapped
 - 2 = Half Word Swapped
 - 3 = Reserved
- Bit 2 Localbuffer Byte control
 - 0 = Standard
 - 1 = Byte Swapped
- Bit 3 Packed 16-bit (1:5:5:5) Framebuffer Control

Turns on 16-bit packed accesses.

 - 0 = disable packed 16-bit framebuffer
 - 1 = enable packed 16-bit framebuffer
- Bit 4 Packed 16-bit Read Buffer Select
 - 0 = select Buffer A for read accesses
 - 1 = select Buffer B for read accesses

- Bit 5 Packed 16-bit Write Buffer Select
 0 = select Buffer A for write accesses
 1 = select Buffer B for write accesses
- Bit 6 Packed 16-bit Double Write Control
 Allows a write access to be performed to both Buffer A and Buffer B simultaneously.
 0 = disable double writes
 1 = enable double writes

3.1.12 Aperture 1 Control Register

The aperture 1 control Register sets up the data transfer modes for the Localbuffer visible in region 3 and the Framebuffer in region 4.

The Localbuffer can be set to be byte swapped for big endian hosts.

The Framebuffer can be set to be byte swapped and half word swapped for big endian hosts.

The Framebuffer can be used in a mode whereby two 16-bit buffers (A and B) are interleaved together on a per-pixel basis. Each 32bit word contains a 16 bit pixel from buffer A and the equivalent pixel from buffer B. Control bits are provided to allow reading and writing of Buffers A and B as contiguous 16-bit packed buffers, despite their being pixel-interleaved within memory. Each 32-bit read or write access over the PCI bus thus transfers two 16-bit pixels to either Buffer A or Buffer B as selected by the fields below.

Aperture 1

Region: 0 Offset: 0000.0058h
 Read/Write Reset Value: 0000.0000h

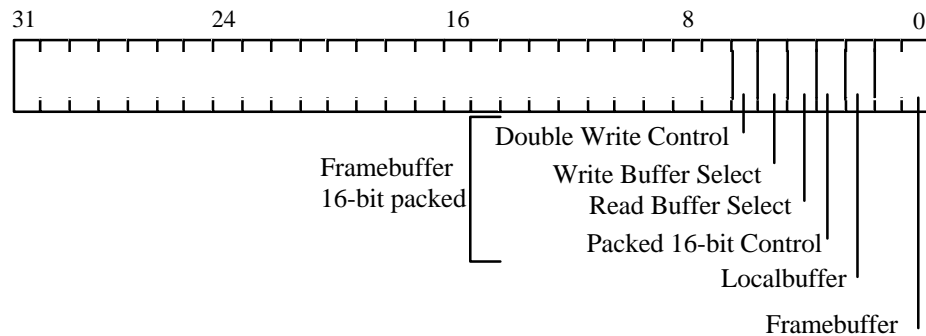

- Bits 1-0 Framebuffer Byte Control
 - 0 = Standard
 - 1 = Byte Swapped
 - 2 = Half Word Swapped
 - 3 = Reserved
- Bit 2 Localbuffer Byte control
 - 0 = Standard
 - 1 = Byte Swapped
- Bit 3 Packed 16-bit (1:5:5:5) Framebuffer Control
 - Turns on 16-bit packed accesses.
 - 0 = disable packed 16-bit framebuffer
 - 1 = enable packed 16-bit framebuffer
- Bit 4 Packed 16-bit Read Buffer Select
 - 0 = select Buffer A for read accesses
 - 1 = select Buffer B for read accesses

- Bit 5 Packed 16-bit Write Buffer Select
 0 = select Buffer A for write accesses
 1 = select Buffer B for write accesses

- Bit 6 Packed 16-bit Double Write Control
 Allows a write access to be performed to both Buffer A and Buffer B simultaneously.
 0 = disable double writes
 1 = enable double writes

3.1.13 DMA Control Register

The DMA control Register sets up the data transfer modes for the DMA controller. Data transfer can be set to byte swapped for big endian hosts.

DMAControl

Region: 0 Offset: 0000.0060h

Read/Write Reset Value: 0000.0000h

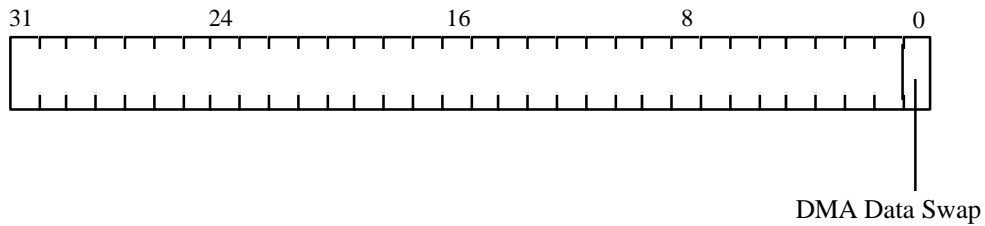

- Bit 0 DMA Byte Swap Control
 0 = Standard
 1 = Byte Swapped

3.1.14 FIFO Disconnect Register

The FIFO Disconnect Register enables input FIFO and output FIFO disconnect on the GLINT 500TX.

Input FIFO and Output FIFO Disconnect are disabled at reset.

FIFODis

Region: 0 Offset: 0000.0068h

Read/Write Reset Value: 0000.0000h

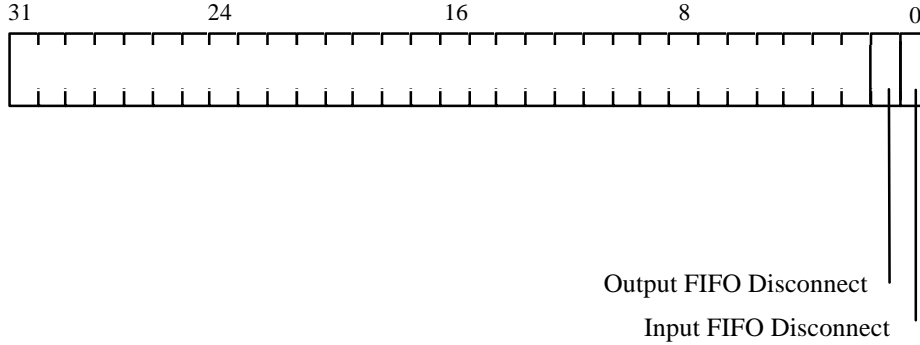

Bit 0 Input FIFO Disconnect enable
 0 = Disabled (RESET)
 1 = Enabled

Bit 1 Output FIFO Disconnect enable
 0 = Disabled (RESET)
 1 = Enabled

N.B. If a GLINT Delta is used with the GLINT 500TX, then the Input FIFO Disconnect must always be enabled on the GLINT 500TX

3.2 Localbuffer Registers

3.2.1 Localbuffer Memory Control

The Localbuffer memory control register sets the characteristics of the Localbuffer DRAM. The register is initialized at reset time by setting values on Localbuffer data pins (see Reset Control, Section 12). Care must be taken when modifying this register to ensure that the DRAM will function within its worst case timings.

LBMemoryCtl

Region: 0 Offset: 0000.1000h
 Read/Write Reset Value: Determined by Localbuffer data pins

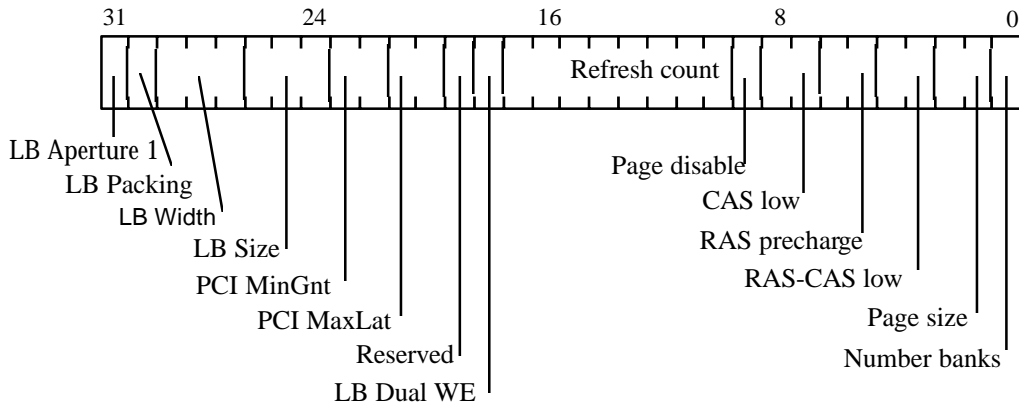

Bit 0 Number of banks LB Reset Bit 0
 Defines the number of banks of CAS interleaved memory in the localbuffer.
 0 = 1 bank
 1 = 2 banks

Bits 2-1 Page size LB Reset Bits 2-1
 Defines the page size of the DRAM of the memory in the localbuffer. If there are 2 banks of memory, the effective page size is twice this value.
 0 = 256 pixels
 1 = 512 pixels
 2 = 1024 pixels
 3 = 2048 pixels

Bits 4-3 RAS-CAS low LB Reset Bits 4-3
 Defines the number of MClks that RAS is asserted before CAS is asserted during a memory access.
 0 = 2 clocks
 1 = 3 clocks
 2 = 4 clocks
 3 = 5 clocks

Bits 6-5	<p>RAS Precharge</p> <p>Defines the RAS Precharge time in terms of MClk periods.</p> <p>0 = 2 clocks 1 = 3 clocks 2 = 4 clocks 3 = 5 clocks</p>	LB Reset Bits 6-5
Bits 8-7	<p>CAS low</p> <p>Defines the CAS low time during a localbuffer access in terms of MClk periods.</p> <p>0 = 1 clock 1 = 2 clocks 2 = 3 clocks 3 = 4 clocks</p>	LB Reset Bits 8-7
Bit 9	<p>Page mode disable</p> <p>Asserting this bit will cause all localbuffer accesses to perform a full DRAM memory cycle. i.e. Fast Page mode is never used.</p> <p>0 = Page mode enabled 1 = Page mode disabled</p>	LB Reset Bit 9
Bits 17-10	<p>Refresh count</p> <p>This field can be used to optimize the DRAM refresh period to the system MClk and the DRAM used for the localbuffer. The refresh period is the value of this field x 16 x MClk period . The Reset value is 20h.</p>	
Bit 18	<p>Localbuffer dual Write enables</p> <p>Read Only</p> <p>x16 DRAM parts come with either 2CAS line and 1 WE line or 1CAS line and 2 WE. The preferred memory parts for GLINT dual CAS lines, however asserting this bit field allows Dual WE parts to be used. In this case, the LBMemCasN lines should be connected to the DRAM WE lines, and the LBMemWeN lines should be connected to the DRAM CAS lines. When x4 or x8 parts are used, this bit should not be set.</p> <p>0 = Dual CAS 1 = Dual Write Enables</p>	LB Reset Bit 18
Bit 19	<p>Reserved Read Only</p>	LB Reset Bit 19
Bits 21-20	<p>PCI Maximum Latency</p> <p>Form the top 2 bits of the configuration space Maximum Latency register</p>	Read Only LB Reset Bits 21-20
Bits 23-22	<p>PCI Minimum Grant</p> <p>Form the top 2 bits of the configuration space Minimum Grant register</p>	Read Only LB Reset Bits 23-22
Bits 26-24	<p>Localbuffer visible region size</p> <p>0 = 1 MByte 1 = 2 MBytes 2 = 4 MBytes 3 = 8 MBytes 4 = 16 MBytes 5 = 32 MBytes 6 = 64 MBytes 7 = 0 MBytes</p>	Read Only LB Reset Bits 26-24

Bits 29-27	Localbuffer width 0 = 16 Bit 1 = 18 Bit 2 = 24 Bit 3 = 32 Bit 4 = 36 Bit 5 = 40 Bit 6 = 48 Bit 7 = Other width	Read Only	LB Reset Bits 29-27
Bit 30	Localbuffer Bypass Packing 0 = 64 bit Localbuffer bypass step 1 = 32 bit Localbuffer bypass step	Read Only	LB Reset Bit 30
Bit 31	Second Localbuffer aperture 0 = Disabled 1 = Enabled	Read Only	LB Reset Bit 31

3.2.1 Localbuffer Memory EDO

The Localbuffer memory EDO register enables and controls the use of EDO DRAM for the Localbuffer and controls the number of page detectors used to control the Localbuffer.

LBMemoryEDO

Region: 0 Offset: 0000.1008h

Read/Write Reset Value: 0000.0000h

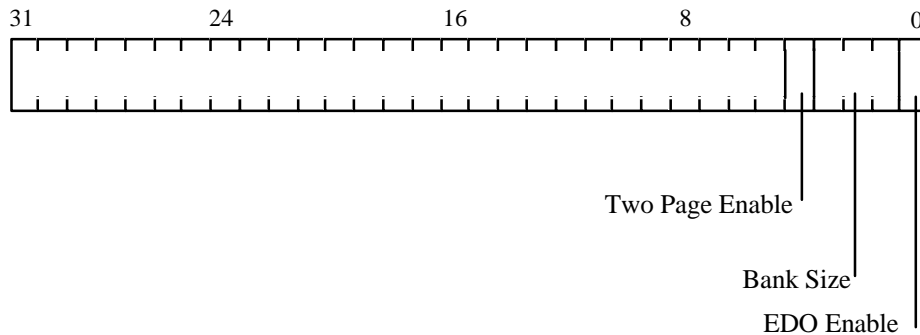

Bit 0 EDO enable
 Enables EDO functionality in the localbuffer.
 0 = EDO disabled (RESET)
 1 = EDO enabled

Bits 3-1 Bank Size
 0 = Second memory bank disabled (RESET)
 1 = Second bank starts at 256K pixels
 2 = Second bank starts at 512K pixels
 3 = Second bank starts at 1M pixels
 4 = Second bank starts at 2M pixels
 5 = Second bank starts at 4M pixels
 6 = Second bank starts at 8M pixels
 7 = Reserved

Bit 4 Two Page enable
 Enables a separate page detectors for each bank of memory .
 0 = Single Page detector (RESET)
 1 = Two Page Detectors Enabled

N.B. Bits 31 to 20 of this register return bits 31 to 20 of the LBMemoryCtl register when read.

Bit 14	Page mode disable Asserting this bit will cause all framebuffer accesses to perform a full VRAM memory cycle. i.e. Fast Page mode is never used. 0 = Page mode enabled 1 = Page mode disabled	FB Reset Bit 6
Bits 19-15	00000h Read only	
Bits 21-20	Reserved	
Bit 22	EDO DRAM This field is for informational purposes only and can be used to correctly configure the Localbuffer through software. 0 = Fast Page Mode DRAM fitted for Localbuffer 1 = EDO DRAM fitted for Localbuffer	FB Reset Bit 22
Bits 25-23	Reserved	FB Reset Bits 25-23
Bit 26	Base Class Zero 0 = GLINT 500TX returns a PCI Base class and sub-class of 03h 80h 1 = GLINT 500 TX returns a PCI Base Class and sub-Class of 00h 00h See Section 2.1.4	Read only FB Reset Bit 26
Bit 27	Reserved Read only	FB Reset Bit 27
Bit 28	Framebuffer Aperture 1 Enable	Read only FB Reset Bit 28
Bits 31-29	Framebuffer Visible Region Size 0 = 1 MByte 1 = 2 MBytes 2 = 4 MBytes 3 = 8 MBytes 4 = 16 MBytes 5 = 32 MBytes 6 = Reserved 7 = 0 MBytes	Read only FB Reset Bits 31-29

3.3.2 Framebuffer Mode Select

The Framebuffer mode select register sets the mode of the Framebuffer VRAM. The register is initialized at reset time by setting values on Localbuffer data pins (see Reset Control, Section 12).

FBModeSel

Region: 0 Offset: 0000.1808h
 Read/Write Reset Value: Determined by Framebuffer data bits

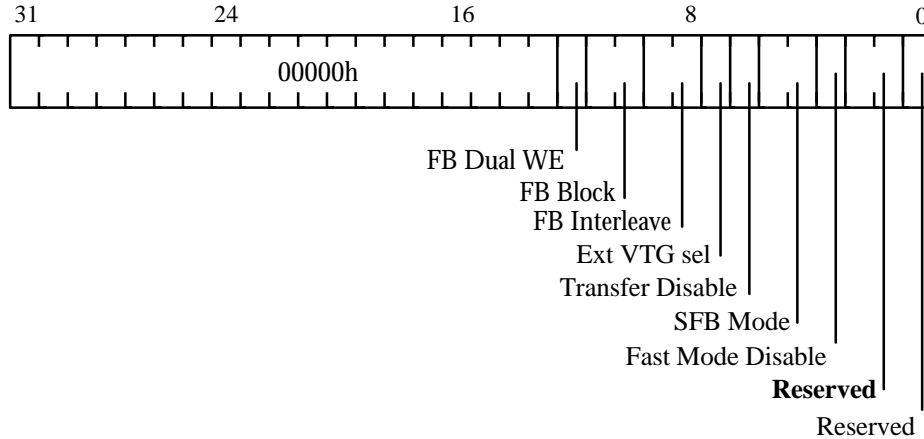

- Bit 0 Framebuffer Width Read Only

This field always returns the value 1 indicating that the Framebuffer width is 64 bits for backward compatibility with the GLINT 300SX.
- Bits 2-1 Reserved

This field always returns the value 3.
- Bit 3 Fast Mode Disable FB Reset Bit 10

Setting this field turns off some of the memory access optimizations.

 - 0 = Fast mode enabled
 - 1 = Fast mode disabled
- Bit 5-4 Shared Framebuffer Mode Read only FB Reset Bits 12-11

If TX Enhanced mode is not set, this 2 bit field determines the Shared Framebuffer mode.

 - 0 = Disabled
 - 1 = Arbiter (Primary controller)
 - 2 = Requester (Secondary controller)
 - 3 = Reserved

This is compatible with GLINT 300SX.

In TX enhanced mode is set , then this field is used in conjunction with the TX Enhanced Shared Memory and SFBModeSwap fields of the TX Shared Memory Control register to determine Shared memory control. See section 7.3 for more details
- Bit 6 Transfer disable FB Reset Bit 13

 - 0 = Video memory transfer cycles enabled
 - 1 = Video memory transfer cycles disabled

Bit 7	External VTG Select 0 = Select internal Video Timing Generator 1 = Select external Video Timing Generator	FB Reset Bit 14
Bits 9-8	Framebuffer interleave This field determines how many interleaved banks of memory are available. e.g. Framebuffer Width = 1 and Framebuffer Interleave = 1 means 2 x64bit banks of memory interleaved by CAS. 0 = 1 way 1 = 2 way 2 = 4 way 3 = Reserved	FB Reset Bits 16-15
Bits 11-10	Framebuffer block fill size The field is used by the memory controller to perform VRAM block fill and selects the block fill size of an individual VRAM. It can be used by the software in conjunction with the values in the Framebuffer Width field and the Framebuffer Interleave field to determine the actual block fill size available to GLINT. 0 = Block fill unsupported 1 = 4 pixel per VRAM block fill 2 = 8 pixel per VRAM block fill 3 = Reserved	FB Reset Bits 18-17
Bit 12	Framebuffer Dual Write Enables x16 VRAM parts come with either 2 CAS line and 1 WE line or 1CAS line and 2 WE. The preferred memory parts for GLINT have dual CAS lines, however asserting this bit field allows Dual WE parts to be used. In this case, the FBMemCasN lines should be connected to the VRAM WE lines, and the FBMemWeN lines should be connected to the VRAM CAS lines. When x4 or x8 parts are used, this bit should not be set. 0 = Dual CAS VRAMs 1 = Dual WE VRAMs	FB Reset Bit 19
Bits 31-13	00000h	

3.3.3 Framebuffer Graphics Core Write Mask

The Framebuffer GC write mask register is a read only register to allow the current Graphics Core write mask to be read. This register is for diagnostic purposes only.

FBGCWrMask

Region: 0 Offset: 0000.1810h

Read Reset Value: FFFF.FFFFh

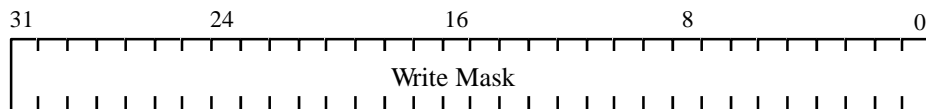

Bits 31-0 Graphics Core Write Mask

3.3.4 Framebuffer Graphics Core Color Lower

The Framebuffer GC color lower register is a read only register to allow the current Graphics Core color low 32 bits to be read. This register is for diagnostic purposes only.

FBGCCColorLower

Region: 0 Offset: 0000.1818h

Read Reset Value: XXXX.XXXXh

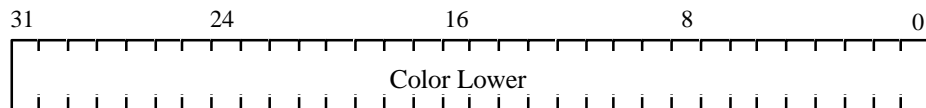

Bits 31-0 Graphics Core Color Mask

3.3.5 Framebuffer TX Shared Memory Control

The Framebuffer TX shared memory control register sets the characteristics of shared framebuffer interface for the GLINT 500TX..

FBTXMemCtl

Region: 0 Offset: 0000.1820h
 Read/Write Reset Value: Determined by TX Control Pin

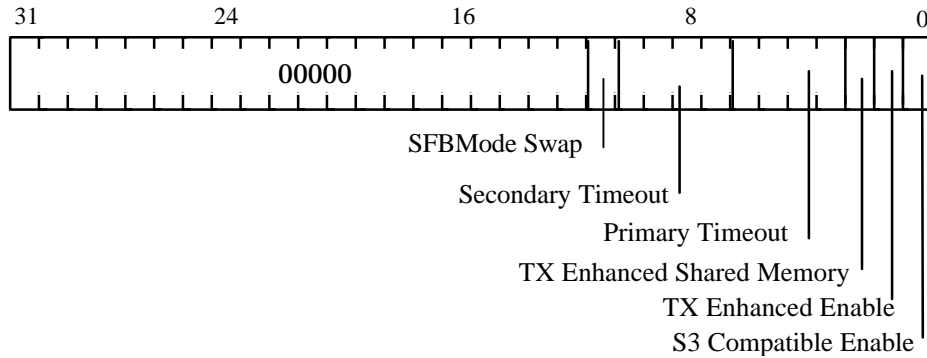

- Bit 0 S3 Compatible Enable
 Sets the Framebuffer memory controller to be compatible with the S3 964/968
- Bit 1 TX Enhanced Enable Read Only TX Control Pin
 Indicates that certain GLINT 500TX enhanced features are available
- Bit 2 TX Enhanced Shared Memory Read Only FB Reset Bit 20
 This bit can only be set if the TXEnhanced pin is pulled high.
 In TX enhanced mode this value is used together with the Shared Framebuffer Mode bits in the FBModeSel register and the SFBModeSwap field to determine the Shared Memory configuration. See Section 7.3.
- Bits 6-3 Primary Timeout
 This 4 bit field provides a timeout count for the Shared Memory arbiter. When GLINT 500TX is a primary controller it will ignore requests from the secondary controller until the timeout counter has reached zero. The timeout period is MClk x 16 .
 Reset value 0h
- Bits 10-7 Secondary Timeout
 This 4 bit field provides a timeout counter for the Shared Memory arbiter. When GLINT 500TX is a primary controller, the timeout counter is used to gate requests from the GLINT 500TX for the memory bus when the secondary controller has the bus. The timeout period is MClk x 16.
 Reset value 0h
- Bit 11 SFBModeSwap Read Only FB Reset Bit 21
 In TX enhanced mode this value is used together with the Shared Framebuffer Mode bits in the FBModeSel register and the TXEnhanced SharedMemory field to determine the Shared Memory configuration. See Section 7.3.

3.3.6 Framebuffer Bypass Write Mask

The Framebuffer write mask register defines the hardware write used for bypass accesses.

FBWrMask

Region: 0 Offset: 0000.1830h
 Read Reset Value: FFFF.FFFFh

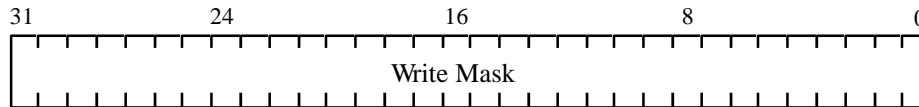

Bits 31-0 Graphics Core Write Mask

3.3.7 Framebuffer Graphics Core Color Upper

The Framebuffer GC color upper register is a read only register to allow the current Graphics Core color high 32 bits to be read. This register is for diagnostic purposes only.

FBGCColorUpper

Region: 0 Offset: 0000.1838h
 Read Reset Value: XXXX.XXXXh

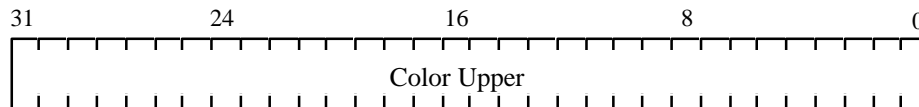

Bits 31-0 Graphics Core Color Upper

3.4 Graphics Core Registers

All the Graphics Core registers in the GLINT 500TX are addressed in this part of region 0. The address for each register and associated data fields is defined in the GLINT Programmers Reference Manual.

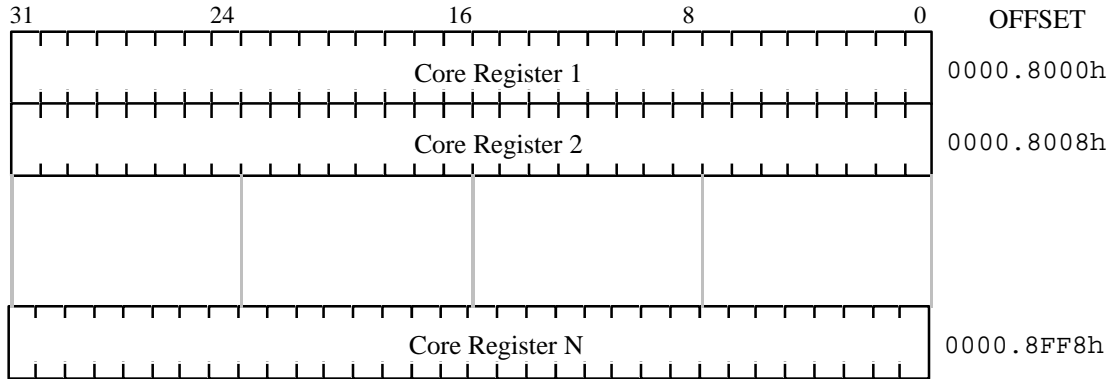

Note. Not all the available register locations are used within the Graphics Core. The registers are on 64 bit boundaries.

3.5 Graphics Core FIFO Interface

The Graphics Core FIFO interface provides a port through which both GC register addresses and data can be sent to the input FIFO. A range of 4 KBytes of host space is provided although all data may be sent through one address in the range. ALL accesses go directly to the FIFO, the range is provided to allow for data transfer schemes which force the use of incrementing addresses. Before writing to the input FIFO the user must check that there is sufficient space by reading the InFIFOSpace register.

If the FIFO interface is used, then data is typically sent to the GLINT 500TX in pairs, an address word which addresses the register to be updated, followed by the data to be sent to the register. Note that the GC registers can not be read through this interface. Command buffers generated to be sent to the input FIFO interface may be read directly by the GLINT 500TX by using the DMA controller.

A data formatting scheme is provided to allow for multiple data words to be sent with one address word where adjacent or grouped registers are being written, or where one register is to be written many times.

For more information on the direct FIFO interface data buffer formats please refer to the GLINT Programmers Reference Manual.

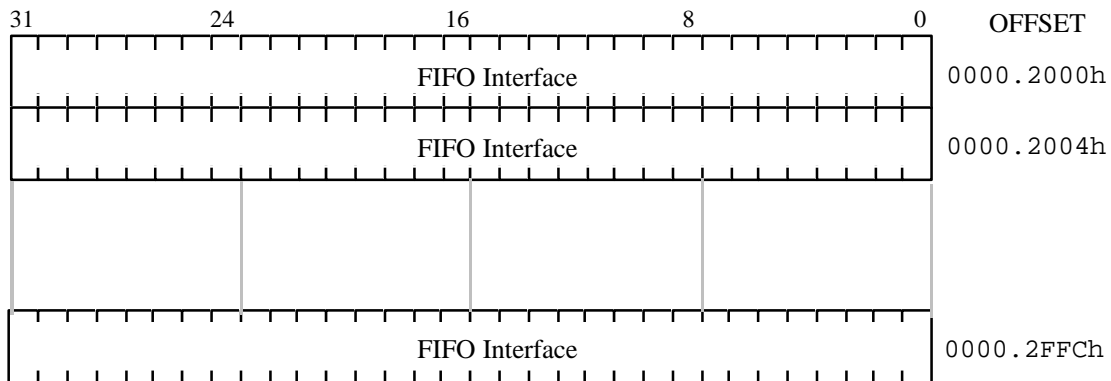

Note. The FIFO interface can be accessed at 32 bit boundaries. This is to allow a direct copy from a DMA format buffer.

4. Internal Video Timing Generator

The GLINT 500TX provides a timing generator to enable a complete framebuffer to be implemented with just the addition of VRAM, video clock generator and a suitable RAMDAC. The timing generator produces appropriate Horizontal and Vertical Syncs and Blanks from an external video clock. It controls the instigation of VRAM transfer cycles in the Framebuffer Interface and provides the VRAM transfer addresses. It also controls the VRAM serial clocks and serial output enables.

It is anticipated that GLINT 500TX will be used with more complex framebuffers than the internal timing generator can drive. For this reason, the timing generator can be disabled and the Framebuffer Interface can be controlled by external circuitry to generate VRAM transfer cycles.

The timing generator is controlled through a series of registers accessible from the PCI bus. There is no access to the timing generator from the GLINT 500TX core.

The timing generator operates entirely from a video clock (VClk). Suitable internal resynchronization occurs between the timing generator and both the PCI interface (PCIClk) and the Framebuffer Interface (MClk).

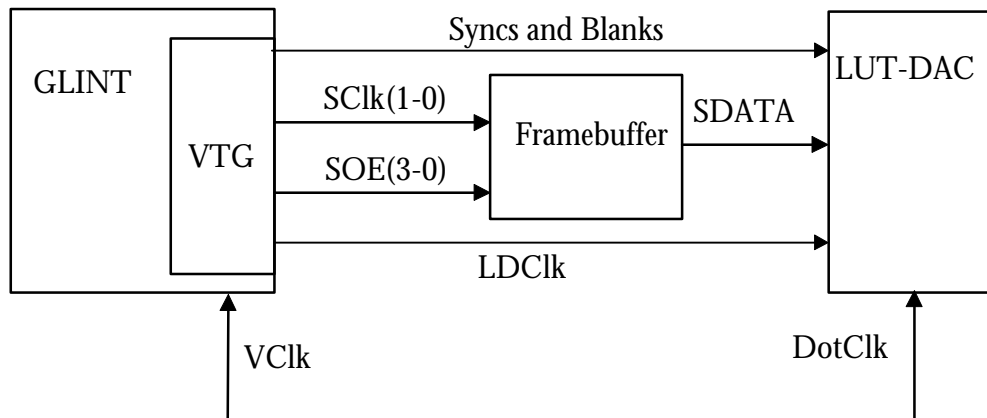

Figure 4-1. Video Timing Generator

4.1 Overview of Internal VTG features

- Generates VSync, HSync, CompositeBlank, CompositeSync, all with programmable polarity.
- 12 bit horizontal and vertical counters.
- Video clock of up to 80 MHz.
- Linearly mapped framebuffer.
- VRAMs with split transfer required.
- VRAMs with and without QSF.
- Programmable size of VRAM split register - 128 or 256.

- Programmable transfer address at start of frame for double buffering support.
- 1, 2 or 4 way Interleaving of VRAM serial outputs.

4.2 Internal VTG Register Set

4.2.1 Horizontal Limit

The Horizontal Limit register defines the horizontal period of the video display. The internal horizontal counter is clocked by VClk. This counter starts at 1, counts to the value set in the Horizontal Count limit register and resets to 1 again.

VTGHLimit

Region: 0 Offset: 0000.3000h

Read/Write Reset Value: 001h

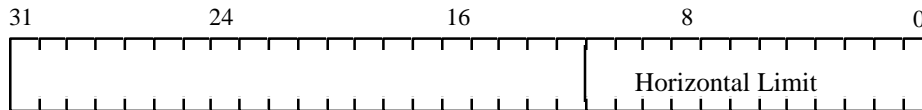

Bits 11-0 Horizontal Limit

4.2.2 Horizontal Sync Start Register

The Horizontal Sync starts when the internal Horizontal Counter reaches the value stored in the Horizontal Sync Start register.

VTGHSyncStart

Region: 0 Offset: 0000.3008h

Read/Write Reset Value: XXXh

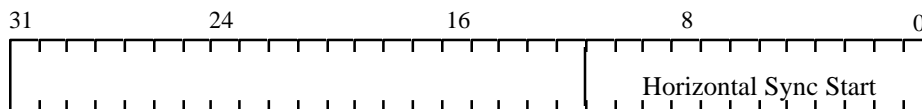

Bits 11-0 Horizontal Sync Start

4.2.3 Horizontal Sync End

The Horizontal Sync ends when the internal Horizontal Counter reaches the value stored in the Horizontal Sync End register.

VTGHSyncEnd

Region: 0 Offset: 0000.3010h

Read/Write Reset Value: XXXh

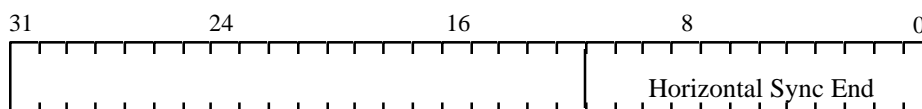

Bits 11-0 Horizontal Sync End

4.2.4 Horizontal Blank End

The Horizontal Blank starts when the internal Counter is reset to 1. The Horizontal Blank ends when the internal Horizontal Counter reaches the value stored in the Horizontal Blank End register.

VTGHBlankEnd

Region: 0 Offset: 0000.3018h

Read/Write Reset Value: XXXh

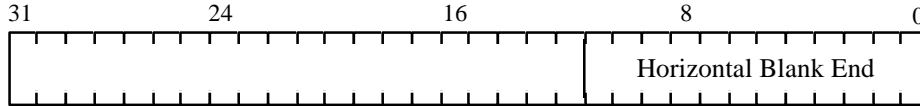

Bits 11-0 Horizontal Blank End

4.2.5 Vertical Limit

The Vertical Limit register defines the vertical period of the video display. The internal vertical counter is clocked by VClk at the start of every Horizontal line. This counter starts at 1 , counts to the value set in the Vertical Count limit register and resets to 1 again.

VTGVLimit

Region: 0 Offset: 0000.3020h

Read/Write Reset Value: 001h



Bits 11-0 Vertical Count

4.2.6 Vertical Sync Start

The Vertical Sync starts when the internal Vertical Counter reaches the value stored in the Vertical Sync Start register.

VTGVSyncStart

Region: 0 Offset: 0000.3028h

Read/Write Reset Value: XXXh

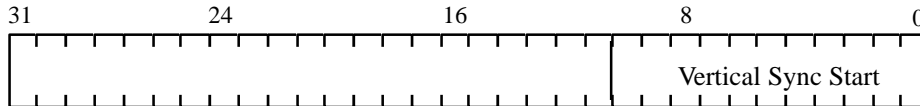

Bits 11-0 Vertical Sync Start

4.2.7 Vertical Sync End

The Vertical Sync ends when the internal Vertical Counter reaches the value stored in the Vertical Sync End register.

VTGVSyncEnd

Region: 0 Offset: 0000.3030h

Read/Write Reset Value: XXXh

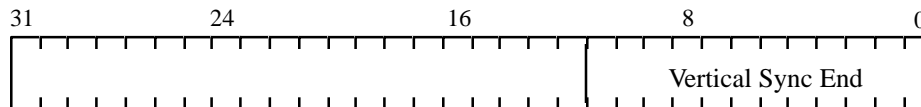

Bits 11-0 Vertical Sync End

4.2.8 Vertical Blank End

The Vertical Blank ends when the internal Vertical Counter reaches the value stored in the Vertical Blank End register.

VTGVBlankEnd

Region: 0 Offset: 0000.3038h

Read/Write Reset Value: XXXh

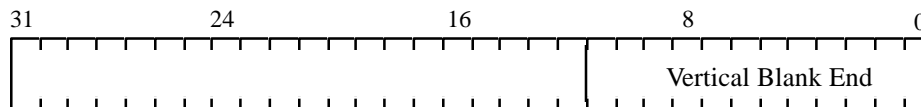

Bits 11-0 Vertical Blank End

4.2.9 Horizontal Gate Start

The Horizontal Gate is an internal signal used to gate the VRAM serial clocks SClk0 and SClk1. Between HGate Start and HGate End, the serial clocks are enabled. The Horizontal Gate is typically set to the inverse of Horizontal Blank with a possible shift to allow for external delays in the Blank and serial clock/data paths. The internal Horizontal Gate signal starts when the internal Horizontal Counter matches Horizontal Gate Start register.

VTGHGateStart

Region: 0 Offset: 0000.3040h

Read/Write Reset Value: XXXh

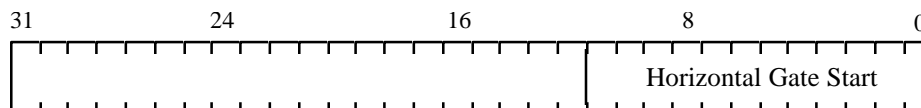

Bits 11-0 Horizontal Gate Start

4.2.10 Horizontal Gate End

The internal Horizontal Gate signal ends when the internal Horizontal Counter matches the Horizontal Gate End register.

VTGHGateEnd

Region: 0 Offset: 0000.3048h

Read/Write Reset Value: XXXh

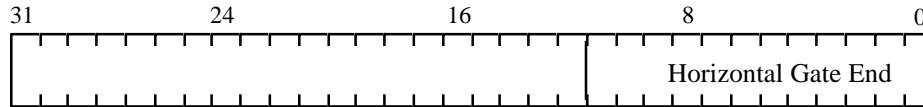

Bits 11-0 Horizontal Gate End

4.2.11 Vertical Gate Start

The internal Vertical Gate signal is used to reset the VRAM transfer cycle controller to perform a full transfer at the start of a frame. It is typically active for the Horizontal line before the end of vertical blank. The internal Vertical Gate signal starts when the internal Vertical Counter matches Vertical Gate Start register.

VTGVGateStart

Region: 0 Offset: 0000.3050h

Read/Write Reset Value: XXXh

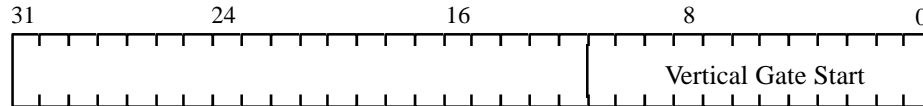

Bits 11-0 Vertical Gate Start

4.2.12 Vertical Gate End

The internal Vertical Gate signal ends when the internal Vertical Counter matches the Vertical Gate End register.

VTGVGateEnd

Region: 0 Offset: 0000.3058h

Read/Write Reset Value: XXXh

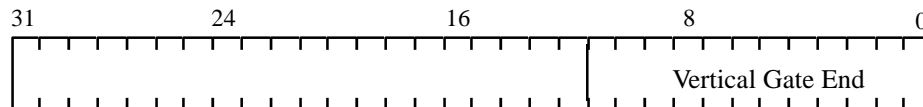

Bits 11-0 Vertical Gate End

4.2.13 Polarity Control

The Polarity Control Register determines the polarities of the output signals HSync, VSync, CBlank and CompSync.

VTGPolarity

Region: 0 Offset: 0000.3060h

Read/Write Reset Value: D5h

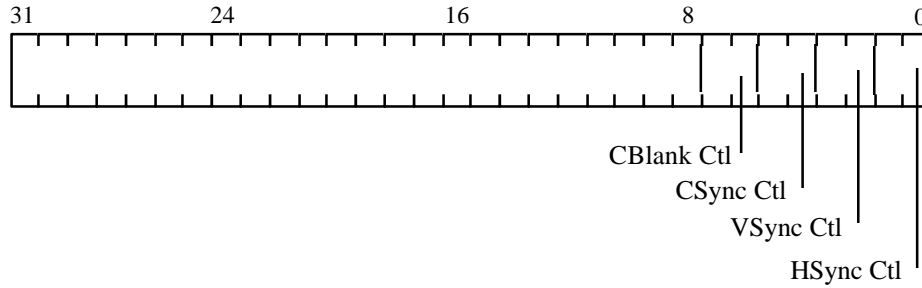

Bits 1-0 HSync Ctl
 0 = Active High
 1 = Forced High
 2 = Active Low
 3 = Forced Low

Bits 3-2 VSync Ctl
 0 = Active High
 1 = Forced High
 2 = Active Low
 3 = Forced Low

Bits 5-4 CSync Ctl
 0 = Active High
 1 = Forced High
 2 = Active Low
 3 = Forced Low

Bits 7-6 CBlank Ctl
 0 = Active High
 1 = Forced High
 2 = Active Low
 3 = Forced Low

4.2.14 Frame Row Address register

The contents of the Frame Row Address register determines the VRAM row loaded into the VRAM shift register at the start of frame. While the frame is active, VRAM split transfers are generated to reload the VRAM shift register. The transfer addresses required are automatically generated internally, starting from this value. At the start of the next frame, a full transfer reloads the shift register with the row specified by this register again. The full transfer split register start address is always zero.

This register can be programmed for double-buffering, if the framebuffer is large enough, by starting the buffers on two different rows and altering the value to swap buffers.

To avoid any possible display artifact, this register should not be changed at the time the VRAM full transfer cycle is occurring at the start of frame. It is recommended that the register is updated during the active vertical period.

VTGFrameRowAddr

Region: 0 Offset: 0000.3068h

Read/Write Reset Value: 00h



Bits 8-0 Frame Row Address

4.2.15 Vertical Line Number

This read only register returns the value of the internal Vertical counter. It can be used to determine when the display is in the vertical blanking interval.

The display is in vertical blanking if the Vertical Line Number is between 1 and the value in the Vertical Blank End register. The display is active if the Vertical Line number is greater than the Vertical Blank End value.

VTGVLineNumber

Region: 0 Offset: 0000.3070h

Read Reset Value: 001h



Bits 11-0 Vertical Line Number

4.2.16 Serial Clock Control

VTGSerialClk

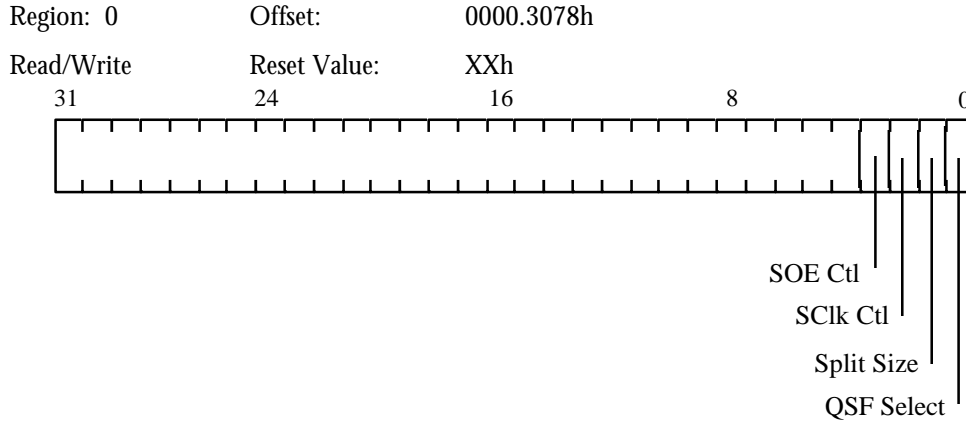

Bit 0 QSF Select

- 0 = External QSF
- 1 = Internal QSF

When this bit is asserted, the transfer address generator counts VRAM serial clocks and generates an internal QSF signal to initiate VRAM transfer cycles. When this bit is negated, the QSF pin is used to initiate transfer cycles. (IBM 4M VRAM do not generate QSF, so an internal QSF must be generated).

Bit 1 Split Size

- 0 = 128 word split transfer register
- 1 = 256 word split transfer register

This bit is set to reflect the size of the VRAM transfer register in split transfer mode. 0 = 128 , 1 = 256. Most 256Kx4 and 256K x 8 VRAMs have a split register of 256. IBM 4M VRAMs have a split register size of 128. This field is used in the generation of the internal QSF.

Bit 2 SClk Ctl

This field is used to control the generation of SCLK0 and SCLK1 as described in section 4.4 below

Bit 3 SOE Ctl

This field is used to control the generation of SOE0 , SOE1, SOE2 and SOE3 as described in section 4.4 below.

4.2.17 Mode Control

VTGModeCtl

Region: 0 Offset: 0000.3080h
 Read/Write Reset Value: 0000h

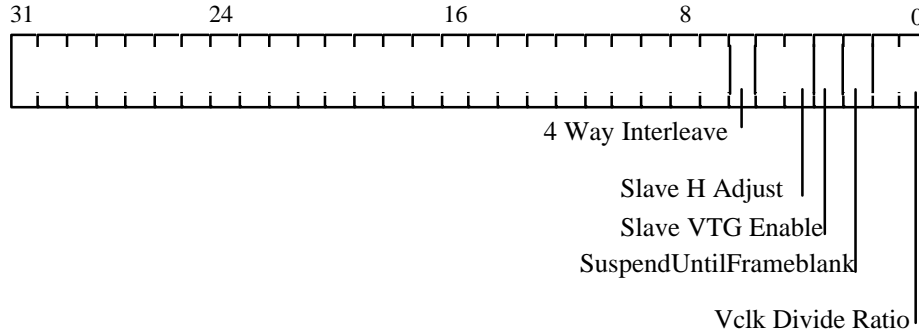

- Bits 1-0 VCLK Divide Ratio
 - 0 = Use VCLK undivided
 - 1 = Use VClk/2
 - 2 = Use VClk/4
 - 3 = Use VClk/8

GLINT 500TX can generate a LDClk which is divided down from the incoming VCLK. The VClk Divide ratio is used to select the division. The SClk and SOE signals are derived from the LDClk. Normal usage has this field at 0.

- Bit 2 SuspendUntilFrameBlank Enable
 - 0 = Complete immediately
 - 1 = wait for VBLANK

The GLINT 500TX has a mechanism in the Graphics Core to flush outstanding writes to the framebuffer and then suspend any succeeding reads or writes until the next vertical blank period. This field is used to enable this feature in the timing generator. If the field is not set then no suspension occurs. This is the reset condition. The field should not be set until the timing generator is running to avoid the possibility of suspending the Graphics Core when no VBLANK will occur.

- Bit 3 Slave VTG Enable
 - 0 = Disable
 - 1 = Enable

This field enables the syncing of the timing generator to an external VSYNC. The master VSYNC is input to the GLINT 500TX on the QSF pin. The polarity of the VSYNC is taken to be the polarity of the internal VSYNC defined in the VTGPolarity register.

Bits 5-4	Slave Hadjust
	0 = adjust by 0 VClks
	1 = adjust by 1 VClks
	2 = adjust by 2 VClks
	3 = adjust by 3 VClks
	This field allows the internal timing generator to be adjusted by a number of VClks relative to the incoming master VSYNC.
Bit 6	4-way Interleave Enable
	0 = Disable
	1 = Enable
	When this bit is set, and the TXEnhanced pin is pulled high, then two additional Serial O/p enables are generated allowing 4 banks of memory to be interleaved into the RAMDAC.

4.3 VTG Configuration

4.3.1 Horizontal Timing Specifications.

A Horizontal counter (VTGHCount) runs off VClk. The counter starts at 1 and counts to the value in VTGHLimit and then reloads. This defines the Horizontal period. i.e. $VTGHLimit \times VClkPeriod$. The horizontal blank and sync timing is derived from this counter and the values stored in the parameter registers.

At reset VTGHLimit is reset with '1'. This effectively freezes the counter until the VTGHLimit register is loaded.

Horizontal blank starts at VTGHCount = 1.

Horizontal blank ends at VTGHCount = VTGHBlankEnd.

Horizontal blank width = $VTGHBlankEnd \times VClkPeriod$.

Horizontal sync. starts at VTGHcount = VTGHSyncStart and ends at VTGHSyncEnd.

Horizontal sync. width = $(VTGHSyncEnd - VTGHSyncStart) \times VClkperiod$.

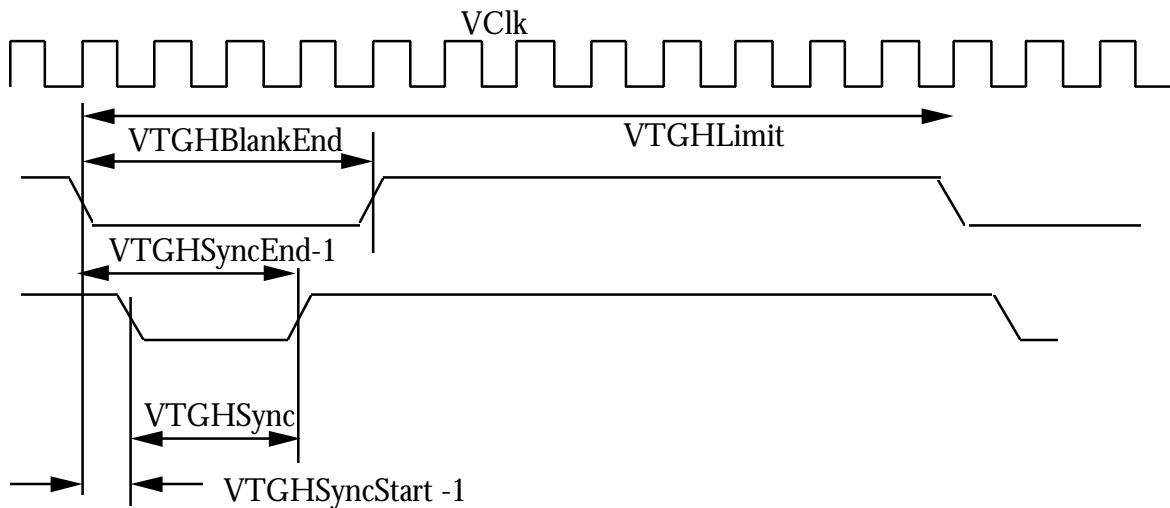

Figure 4-2. Horizontal Timing

4.3.2 Vertical Timing Specifications.

The vertical signals are specified in terms of numbers of lines. A vertical counter (VTGVCOUNT) counts lines starting at 1 and counts to the value in VTGVLIMIT and then reloads. The vertical period or frame rate is defined as VTGVLIMIT x Horizontal period. This is VTGVLIMIT x VTGHLIMIT x VCLKPERIOD. The vertical blank and sync timing is derived from this counter and the values stored in the parameter registers.

At reset VTGVLIMIT is reset with '1'. This effectively freezes the counter until the VTGVLIMIT register is loaded.

Vertical Blank is asserted on the active edge of Horizontal blank

Vertical blank starts at VTGVCOUNT = 1 and

Vertical blank ends at VTGVCOUNT = VTGVBLANKEND.

Vertical blank width = VTGVBLANKEND x HorizontalPeriod.

The Vertical sync is asserted on the active edge of Horizontal sync.

Vertical sync starts at (VTGVCOUNT = VTGVSYNCSTART - 1)

Vertical sync ends at VTGVSYNCEM - 1

Vertical sync. width = (VTGVSYNCEM - VTGVSYNCSTART) x HorizontalPeriod

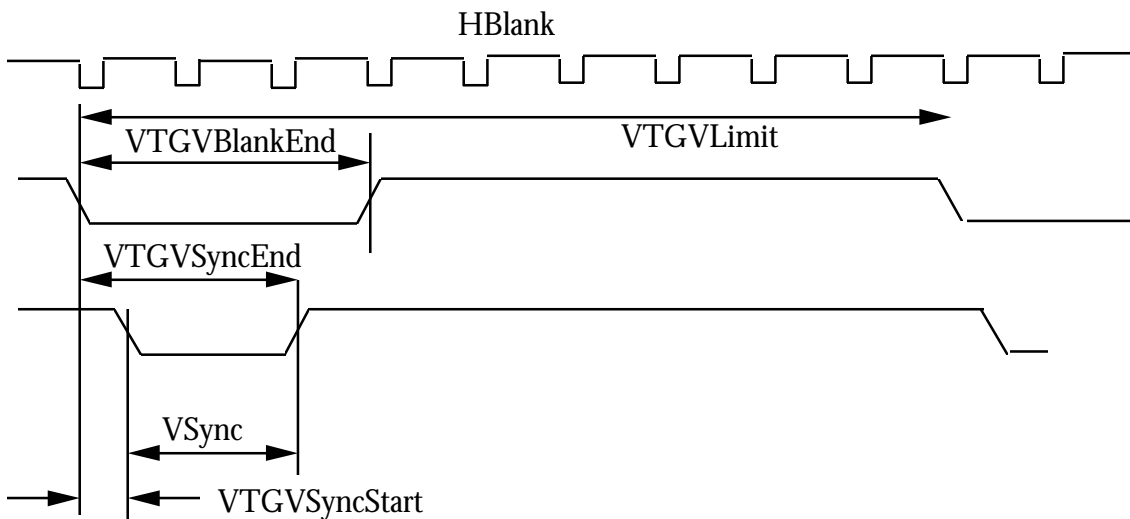

Figure 4-3. Vertical Timing

4.3.3 Sync and Blank Generation

Composite Sync (CompSync.) is the logical OR of HSync and VSync.

Composite Blank (CBlank) is the logical OR of HBlank and VBlank.

VSyn, HSync, CompSync and CBlank are all outputs from GLINT 500TX. The polarity of these signals is controlled by the Polarity Control Register.

4.3.4 Vertical and Horizontal Gate Specification

Hgate is generated from VTGHGateStart and VTGHGateEnd in the same way as Hsync. i.e.

$$\text{Hgate} = (\text{VTGHGateEnd} - \text{VTGHGateStart}) \times \text{VClkPeriod}$$

Similarly VGate is generated from VTGVGateStart and VTGVGateEnd

$$\text{VGate} = (\text{VTGVGateEnd} - \text{VTGVGateStart}) \times \text{HorizontalPeriod.}$$

VGate and HGate are used to control the VRAM transfer requester and to gate the VRAM serial clock. HGate is typically set to be the inverse of HBlank with a shift of a number of clocks to allow the VRAM serial data to reach the RAMDAC synchronized correctly to the blanking signal. VGate is typically set during the line before the end of Vertical Blank.

4.3.5 VRAM Transfer Control

The video display from GLINT 500TX is generated by connecting the framebuffer VRAM serial ports to the RAMDAC. The VRAM serial shift registers must be kept loaded with the correct data to generate the display. The framebuffer must be linearly mapped to use the internal timing generator/transfer address controller.

At the end of the vertical blanking, a VRAM full transfer cycle is performed using the address loaded in the Frame Row Address register. This defines the VRAM RAS address start point.

The VRAM serial clock (SClk) is gated with HGate and VGate to only clock during the active part of active lines. If an external QSF signal is available which indicates when the VRAM shift register is half empty, split transfer cycles are performed which reload the empty half of the shift register. This continues until the end of the frame.

If no external QSF signal is available then the Internal QSF bit of the Serial Clock Control register must be set. An internal QSF is generated by effectively counting SClks until the size of the VRAM split register is reached and QSF is toggled. Split register sizes of both 256 bits and 128 bits are supported by setting the Split RegisterSize bit of the Serial Clock Control register appropriately.

For a split register size of 256, the row address and column address bit 8 is incremented every time QSF toggles. For a split register size of 128, the row address and column address bits 8 and 7 are incremented every time QSF toggles.

4.4 VRAM Serial Port Control

There are numerous ways of controlling the framebuffer serial port to generate the display. The serial port interleave may be one, two or four way depending on the number of banks of memory and the RAMDAC port width. The register settings for these different interleaves is listed in Table 4.1 below.

Table 4.1. Options For Serial Port Control

4way	TX Enhanced	SOE Ctl	SCLK Ctl	Display source	SCLK freq.	serial port interleave
X	0	0	0	SOE0	LDCLK	1-way bank0
X	0	1	0	SOE1	LDCLK	1-way bank1
X	0	X	1	SOE0,1	LDCLK/2	2-way bank0,1
0	1	0	1	SOE0,1	LDCLK/2	2-way bank0,1
0	1	1	1	SOE2,3	LDCLK/2	2-way bank2,3
1	1	X	X	SOE0,1,2,3	LDCLK/4	4way

The first 3 modes are compatible with GLINT 300SX. The latter 3 modes are new to GLINT 500TX.

4.4.1 One-Way Interleaved

Serial data is clocked out of either Bank 0 or Bank 1. This is controlled using the SOE Ctl field of the Serial Clock Control register. There is no dynamic switching from bank 0 to bank 1.

SCLk0 and SCLk1 are identical in this case and are gated versions of the RAMDAC LDClk.

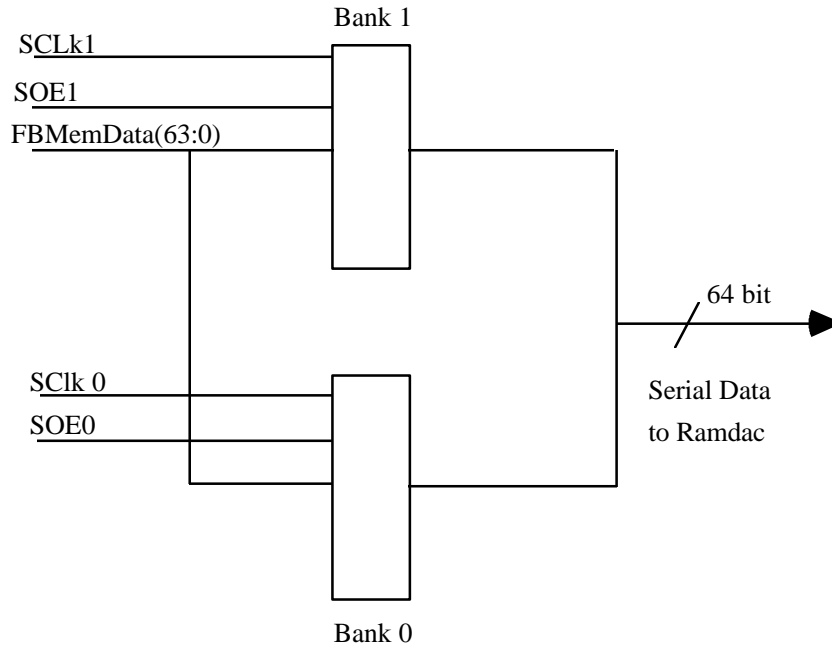

Figure 4.4 Serial Control of 1-Way interleaved Display.

4.4.2 Two-Way Interleaved

In this mode, Bank 0 and Bank 1 are interleaved, and the display is taken alternately from each using SOE0 and SOE1. SCLK0 and SCLK1 are again gated on during the active scan line and run at RAMDAC LDClk/2. This is compatible with GLINT 300SX.

If the GLINT 500TX has the TXEnhanced pin pulled high, then the SOE2 and SOE3 pins are activated. These can be used to allow display from an additional 2 banks of memory. In two-way interleaved mode the SOE Ctl field of the Serial Clock Control register is used to select whether the Bank 0 and Bank 1 are outputting data onto the Serial data bus, or whether Bank 2 and Bank 3 are used.

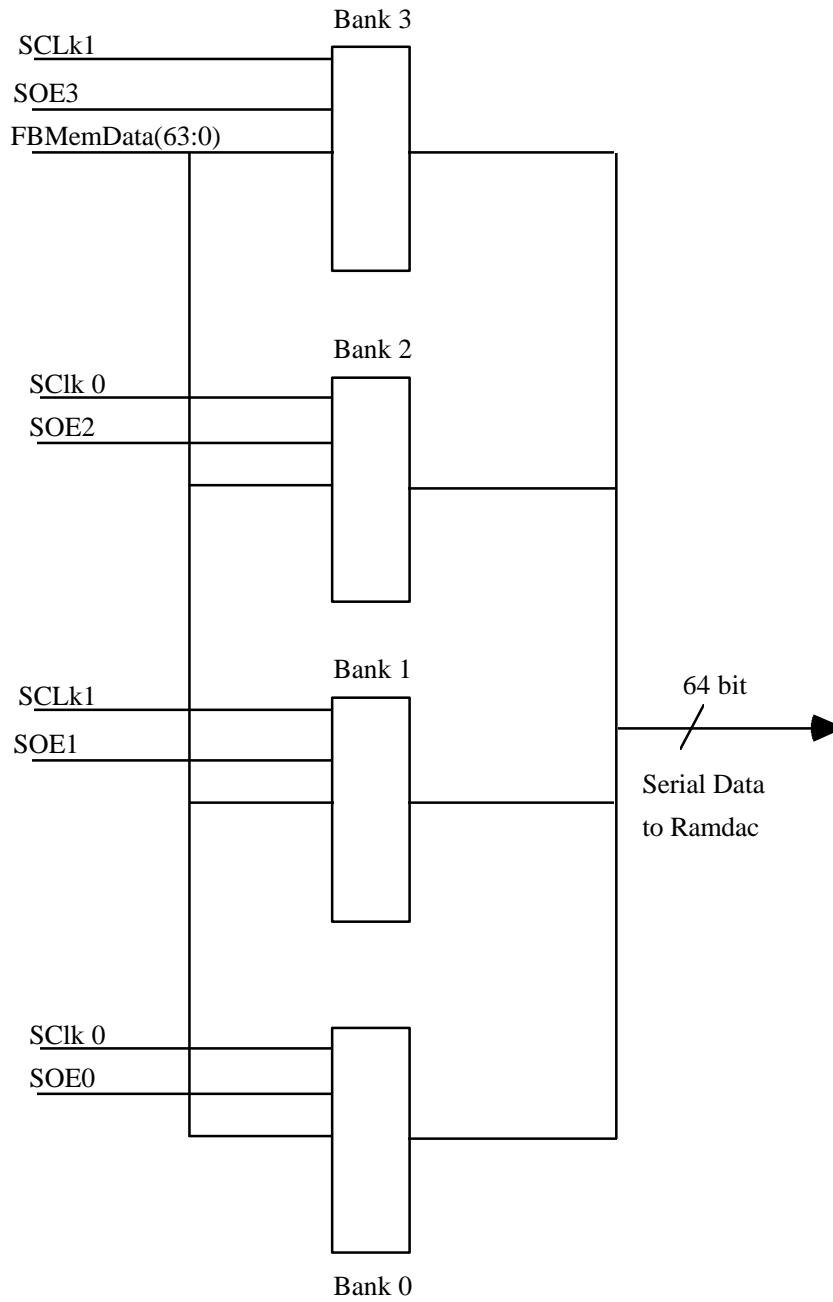

Figure 4.5 2-Way Or 4-Way interleaved Serial Port With 64bit RAMDAC.

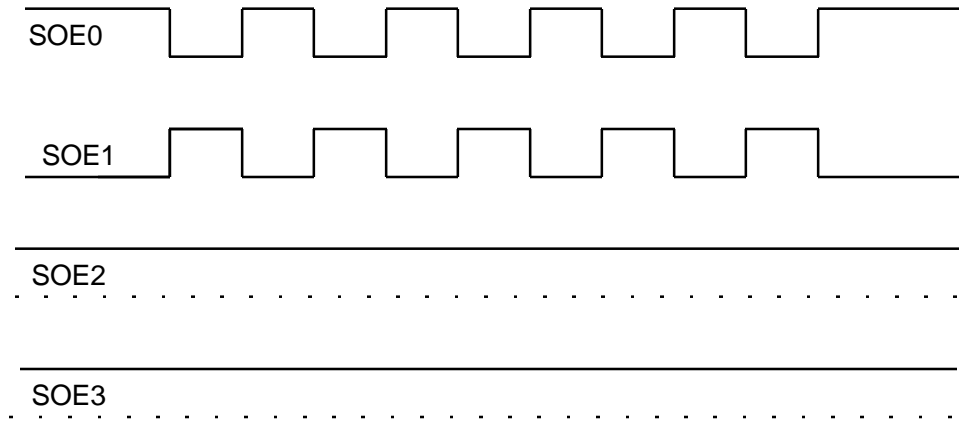

Figure 4.6 2-Way Interleaved With TX Enhanced = 1 , SOE Ctl = 0.

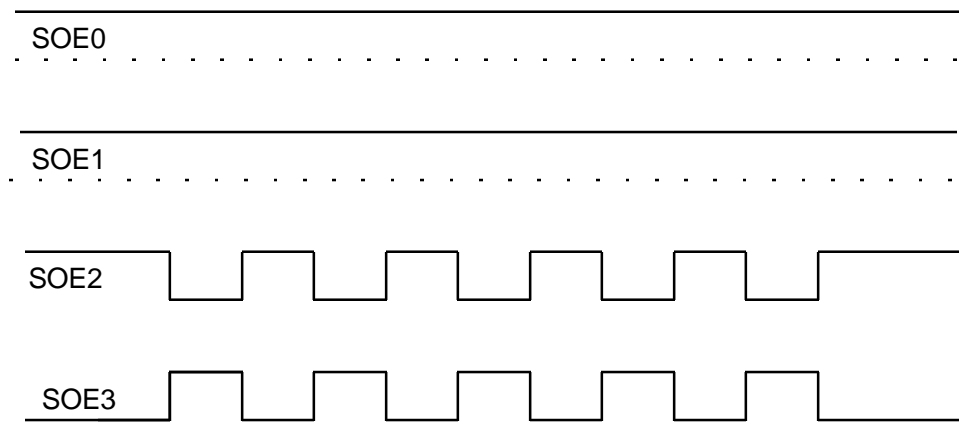

Figure 4.7 2-Way Interleaved With TX Enhanced = 1 , SOE Ctl = 1.

4.4.3 Four-Way Interleaved

This mode is connected to the VRAM serial port exactly the same way as the two-way interleaved mode. The GLINT 500TX drives the SOE of each of the 4 banks low in turn. Note that banks 0 and 2 are connected to SCLK0 and banks 1 and 3 to SCLK1.

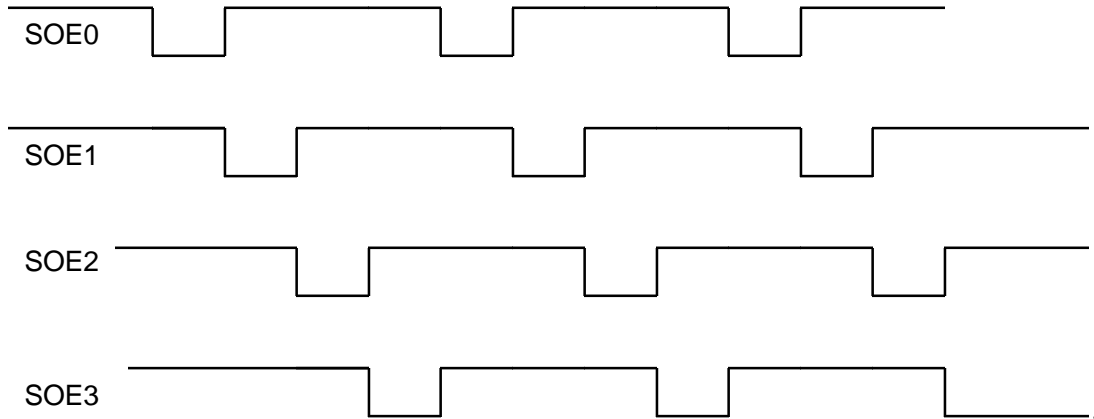

Figure 4.8 4-Way interleaved Serial Port.

If a 64-bit RAMDAC is used, then the interleave of the VRAM serial port must match the interleave of the VRAM random port as defined in the Interleave field of the FBModeSel register.

If a 128-bit RAMDAC is used, then the interleave of the VRAM serial port must be half the interleave of the VRAM random port.

In general, the higher the interleave value of the serial port, the faster the pixel rate that can be displayed and hence the higher the resolution. However, more banks of memory must be fitted.

4.5 VTG Example

The timing specification for the VESA 800 x 600 at 60 Hz mode 6Ah are as follows :-

	Horizontal Time	Characters	Vertical Time	Lines
Dot Clock	40 MHz			
Sync. Polarity	Positive		Positive	
Frequency	37.879 KHz		60.3165 Hz	
Period	26.4 uS	132	16.579 ms	628 lines
Blanking Time	6.4 uS	32	0.739 ms	28 lines
Sync Width	3.2 uS	16	0.106 ms	4 lines
Back Porch	2.2 uS	11	0.607 ms	23 lines
Active Time	20.0 uS	100	15.840 ms	600 lines
Front Porch	1.0 uS	5	0.026 ms	1 line

For a system with 32 bits per pixel and a 2 to 1 interleave on the serial data i.e. VLCK = Dot Clock /2 then the following register values can be used.

Register Name	Value	Explanation
VTGHLimit	528	132 x 8 pixel chars. 2 pixels per VCLK
VTGHSyncStart	20	Front porch *8 /2
VTGHSyncEnd	84	(FrontPorch + SyncWidth)*8/2
VTGHBlankEnd	128	(Blanking time) *8/2
VTGVLimit	628	Vertical Period
VTGVSyncStart	2	Front Porch +1
VTGVSyncEnd	6	Front Porch + SyncWidth +1
VTGVBlankEnd	28	Blanking Time
VTGHGateStart	HBlankEnd -2	Example value (system dependent)
VTGHGateEnd	HLimit -2	Example value (system dependent)
VTGVGateStart	VBlankEnd -1	
VTGVGateEnd	VBlankEnd	

5. External Video Control Registers

GLINT 500TX provides an 8 bit general purpose interface to allow external devices to be addressed from the PCI. This interface has a 16Kbyte address space and is specified as the external video control register region. It allows up to 2048 x 8bit registers to be accessed on 64 bit boundaries. On a typical system, this interface is used to address the LUT-DAC. On more advanced designs, when an external video timing generator or other controllable video circuitry is used, these can also be addressed through this register space. The interface consists of address, data and two control lines. The address and data lines share pins with the Localbuffer data pins.

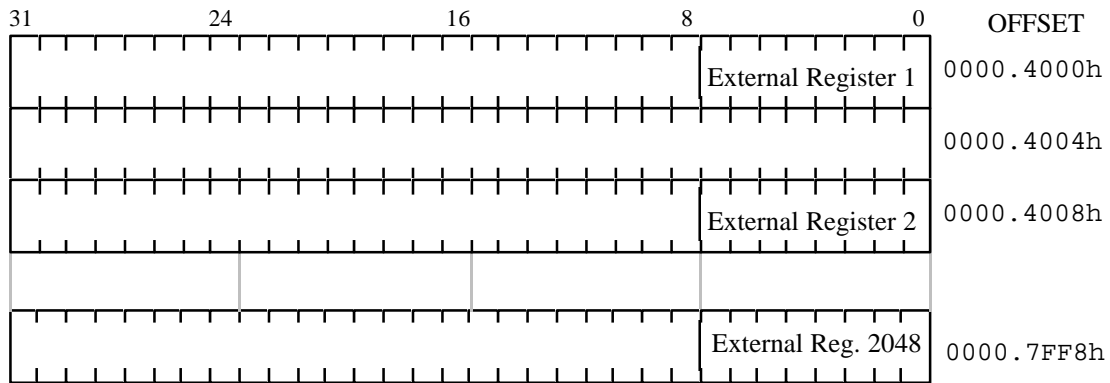

5.1 External Video Interface Signal Definitions

The following signals are defined for the External Video Interface:

Table 5-1. External Video Signals

Signal	Pins used	Description
Ext VidAddress(13-3)	LBMemData(37-27)	External Video register Address lines. Note that the registers are on 64 bit PCI boundaries.
ExtVidData(7-0)	LBMemData(47-40)	External Video Data bus.
DacRdN	DacRdN	External Video register read strobe (negative active)
DacWrN	DacWrN	External Video register write strobe (negative active)

See Chapter 9 for signal waveforms and timing.

5.2 LUT-DAC Interface.

A typical LUT-DAC would be connected to GLINT 500TX through the External Video Interface as shown in figure 5-1.

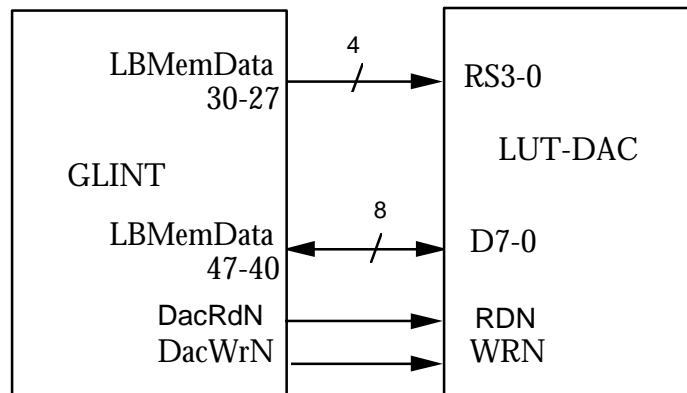

Figure 5-1 Typical LUT-DAC Interface.

When additional External Video circuitry is required, the DacRdN, DacWrN and ExtVidAddress must be externally decoded to generate any required select or control lines.

5.3 Resetting External Circuitry

External circuitry connected to GLINT may need a reset signal. This cannot be obtained directly from the PCI reset line as this can only have one load, the GLINT chip itself. GLINT uses two of its external circuitry control pins, RomEnN and DacWrN, when asserted together to indicate a reset. The pins are asserted when either the PCIRstN line to GLINT is asserted or when GLINT is reset by software.

Reset is indicated for the full length of a PCI reset and for 64 MClk cycles when a soft reset is initiated.

6. Localbuffer

6.1 Configurations - DRAM Types.

The GLINT 500TX uses the Localbuffer to store depth, stencil, Fast Clear, Graphics ID and texture information. The Localbuffer may be up to 48 bits wide. The following tables indicate typical Localbuffer configurations.

Table 6-1. Localbuffer Sizes With 4Mbit Technology Memories

Memory Device Type	Localbuffer Width	No of Devices	Banks of Memory	Size in MBytes	External Buffering
256K x 16	32	4	2	2	No
	48	6	2	3	No
512K x 8	32	4	1	2	No
	40	5	1	2.5	No
	48	6	1	3	No
512K x 8	32	8	2	4	No
	40	10	2	5	No
	48	12	2	6	No
1M x 4	32	8	1	4	No
	40	10	1	5	No
	48	12	1	6	No
1M x 4	32	16	2	8	Yes
	40	20	2	10	Yes
	48	24	2	12	Yes

Table 6-2. Localbuffer Sizes With 16Mbit Technology Memories

Memory Device Type	Localbuffer Width	No of Devices	Banks of Memory	Size in MBytes	External Buffering
1M x 16	32	4	2	8	No
	48	6	2	12	No
2M x 8	32	4	1	8	No
	40	5	1	10	No
	48	6	1	12	No
2M x 8	32	8	2	16	No
	40	10	2	20	No
	48	12	2	24	No
4M x 4	32	8	1	16	No
	40	10	1	20	No
	48	12	1	24	No
4M x 4	32	16	2	32	Yes
	40	20	2	40	Yes
	48	24	2	48	Yes

Table 6-3. Localbuffer Field Sizes.

Depth, Stencil, Fast Clear and Graphics ID information for each pixel is packed and stored together. The following table shows the possible widths for each field.

Field	Possible Field Widths
Depth (Z)	16,24,32
Stencil	0,4,8
Fast Clear	0,4,8
Graphics ID	0,4

The widths of each field is dynamically programmable and so it can be different in different windows. The only limitation is that the sum of the field widths must be less than or equal to the physical number of Localbuffer bits provided by the hardware.

For more information on field use refer to the GLINT 500TX Programmers Reference Manual.

Textures are always stored in the bottom 32 bits of the each Localbuffer location. If the Localbuffer exceeds 32 bits in width , the bits above 32 are unused for texture storage.

6.2 PCI Region 1 and Region 3 Address Map.

The GLINT 500TX PCI regions 1 and 3 are two apertures into the bypass interface to the Localbuffer memory. The amount of memory visible from the host is configured at reset by the Localbuffer data pins. Also region 3 can be disabled at reset time. If region 3 is enabled the visible size is the same as for region 1.

Refer to Reset Control (Section 12) for more information on the operation at reset.

Table 6-4. Localbuffer Visible Bypass Memory.

Reset Code	Visible Memory	Address Range
0	1 MByte	0000.0000h - 000F.FFFFh
1	2 MBytes	0000.0000h - 001F.FFFFh
2	4 MBytes	0000.0000h - 003F.FFFFh
3	8 MBytes	0000.0000h - 007F.FFFFh
4	16 MBytes	0000.0000h - 00FF.FFFFh
5	32 MBytes	0000.0000h - 01FF.FFFFh
6	64 MBytes	0000.0000h - 03FF.FFFFh
7	Reserved	Bypass Disabled

6.3 Localbuffer Memory Types

The GLINT 500TX supports 1 or 2 banks of either fast page mode or EDO DRAM. The default memory controller setup is to assume fast page mode DRAM. The memory access timings can be adjusted by programming the LBMemoryCtl register. When two banks of

memory are fitted, the default configuration is to interleave the memories on a per location basis. These defaults are compatible with GLINT 300SX.

The GLINT 500TX allows the two banks of memory to be accessed separately, so that each can have an open page. This can give improved memory access performance if textures are stored in one bank of memory and Depth/Stencil/Fast Clear/Graphics ID information is stored in the other. This mode of operation is enabled through the Two Page enable field of the LBMemoryEDO register. The size of the first bank of memory must be known and the BankSize field must also be set to map the two banks of memory into a contiguous space.

The benefit of using EDO DRAM is that it allows page mode memory accesses to be performed in 1 clock cycle (as opposed to a minimum of 2 cycles for fast page mode devices). If EDO DRAM is fitted, the GLINT 500TX can be configured to perform single cycle EDO page mode accesses. This is enabled by setting the EDO Enable field of the LBMemoryEDO register. In this case the CAS-Low field of the LBMemoryCtl register is ignored and a single cycle CAS phase is performed during the memory access. If two banks of memory are fitted, the BankSize field must also be set. The banks are never interleaved if EDO accesses are enabled. There is no method to automatically configure the Localbuffer into EDO accesses, the LBMemoryEDO register must be configured through software.

FBMemCtrl register bit 22 is being used to indicate that EDO DRAM is fitted.

The method for turning on the Two Page detectors and EDO through software is :

- 1) Check for 1 or 2 banks of Local buffer - if 1 bank, leave Memsize field at value 0.
- 2) Probe the size of Localbuffer memory.
- 3) Set the Memsize field above to half way through the memory, e.g. a configuration with 8Mbytes of local buffer memory of width 32 bits (= 2 MPixels) should have the field set to 3.
- 4) Set the TwoPageEnable field.
- 5) Read FBMemCtrl register bit 22 (EDO DRAM field).
- 6) If set, then set the EDO mode field of the LBMemoryEDO register.

6.4 Localbuffer Example Configuration

Figure 6.1 is an example Localbuffer configuration. This is an 8 MByte buffer in two banks constructed of 1Mx16 memory devices . Note only 32 bits of Localbuffer width is provided. LBMemCasN(3:0) are used as byte enables. LBMemCasN(5:4) and LBMemData(48:32) are unused.

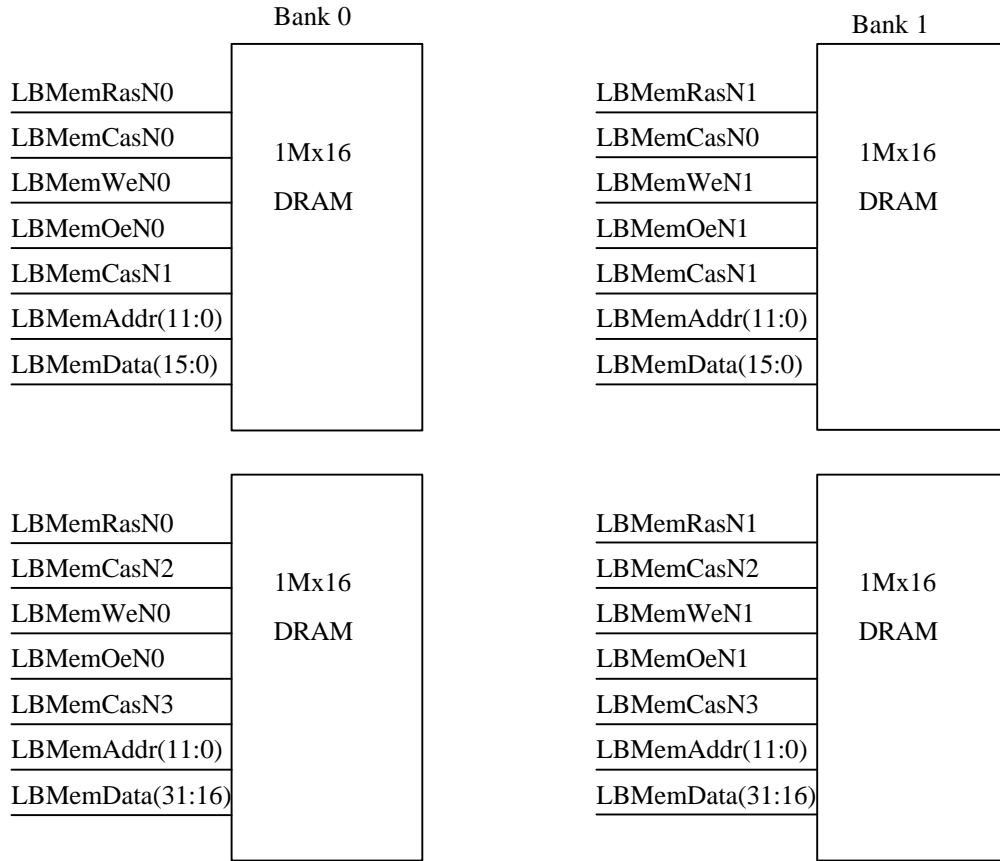

Figure 6-1 8MByte Localbuffer (32 bit wide)

6.5 Shared Localbuffer

The Shared Framebuffer protocol on the GLINT 300SX has been extended on the GLINT 500TX to allow the Localbuffer to be shared with another device. When this is enabled , the GLINT 500TX either drives or tri-states all Localbuffer Address, Data and control lines depending on whether or not it is controlling the memory. See Section 7.3 for more information.

7. Framebuffer

7.1 Configurations - VRAM Types and Features

Table 7-1. Framebuffer Configurations

Framebuffer Size (MBytes)	VRAM Data Bus Width	Data Width to LUT-DAC	Max supported Resolutions	Number of Random Port Banks	Serial Port Interleaved Banks	Timing Generator
2MByte	64	32/64	800x600x24 1024x768x16 1600x1200x8 800x600x16 DB 1024x768x8 DB	1	2/1	Internal
4MByte	64	64/128	1024x768x24 1600x1200x16 800x600x24 DB 1024x768x16 DB 1600x1200x8 DB 2048x2048x8	2	2/1	Internal
8MByte	64	64/128	1600x1200x24 1024x768x24 DB 1600x1200x16 DB 1600x1200x8 DB 2048x2048x8 DB 2048x2048x16	4	4/2	Internal / External
16MByte	64	128	1600x1200x24 DB 1600x1200x16 DB 1600x1200x8 DB 2048x2048x8 DB 2048x2048x16 DB	8	2x2	Internal / External

Notes:

1. For resolutions shown with 24 bit pixels, the pixels are on 32 bit boundaries.
2. DB indicates support for double buffering at this resolution.

The pixel ordering in the packed modes is shown below.

Table 7-2. Framebuffer Pixel Packing

Packing	Framebuffer Data Word			
	0 - 7	8 - 15	16 - 23	24 - 31
32 bit	Pixel 1			
16 bit	Pixel 1		Pixel 2	
8 bit	Pixel 1	Pixel 2	Pixel 3	Pixel 4

7.2 PCI Region 2 and Region 4 Address Map

The GLINT 500TX PCI regions 2 and 4 are the two apertures into the bypass interface to the Framebuffer memory. The amount of memory visible from the host is configured at reset by the Framebuffer data pins. Also region 4 can be disabled at reset time. If region 4 is enabled the visible size is the same as for region 2.

Refer to Reset Control (Section 12) for more information on the operation at reset.

A 32 bit Hardware Write Mask register is provided to condition all bypass write accesses to the Framebuffer. See Section 3.3.6 for more details.

Table 7-3. Framebuffer Visible Bypass Memory

Reset Code	Visible Memory	Address Range
0	1 MByte	0000.0000h - 000F.FFFFh
1	2 MBytes	0000.0000h - 001F.FFFFh
2	4 MBytes	0000.0000h - 003F.FFFFh
3	8 MBytes	0000.0000h - 007F.FFFFh
4	16 MBytes	0000.0000h - 00FF.FFFFh
5	32 MBytes	0000.0000h - 01FF.FFFFh
6	Reserved	
7	0 MBytes	Bypass Disabled

Some LUT-DACs have a display format whereby a 16 bit display is scanned out of either the low 16 bits of every 32 bit Framebuffer word, or the high 16 bits of every Framebuffer word. These are referred to as Buffer A and Buffer B respectively. The Graphics Core supports this type of unpacked Framebuffer. However 32 bit bypass accesses in this mode would normally access 1 pixel from each buffer. A 16 bit packed access mode has been provided which allows a 32 bit bypass access to access 2 consecutive pixels in either Buffer A or Buffer B. This mode is controlled by programming the Aperture Control registers. See sections 3.1.11 and 3.1.12.

Examples of different Packed write modes are given below:

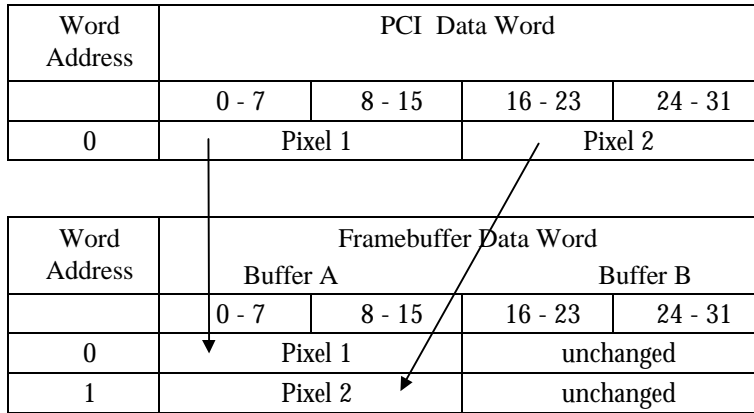

Figure 7-1 Packed Write to Buffer A

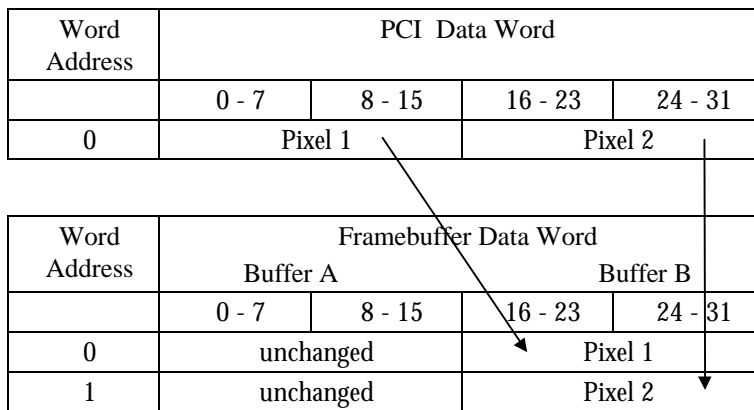

Figure 7-2 Packed Write to Buffer B

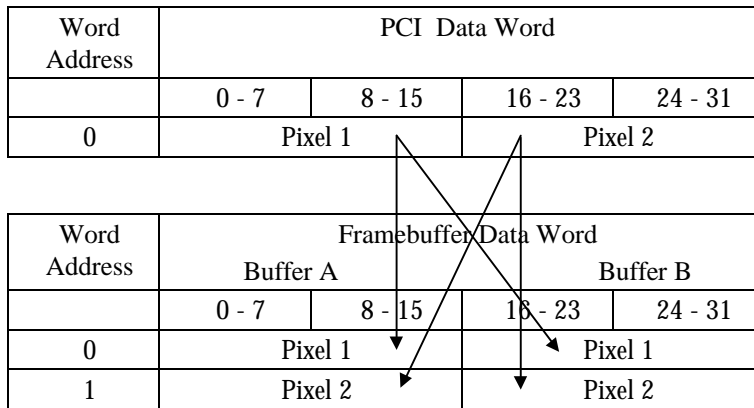

Figure 7-3 Packed Write to Buffer A and Buffer B

7.3 Shared Framebuffer/Shared Memory Interface.

The GLINT 500TX expands the functionality of the Shared Framebuffer interface on GLINT 300SX to allow either the Framebuffer or the Localbuffer or both buffers to be shared with another device. The selection of which buffer (if any) is shared is determined at reset time by configuration resistors on the FBMemData bus. The GLINT 300SX uses the SFBMode field of the FBModeSel register to determine the configuration. The GLINT 500TX uses the SFBMode field and, in addition, the TX Enhanced Shared Memory field and the SFBModeSwap field of the FBTXMemCtl register to determine the configuration as specified in table 7-4.

The SFBModeSwap field and the TX Enhanced Shared Memory fields are only activated if the TXEnhanced pin is pulled high. This is to allow backwards compatibility with the GLINT 300SX.

The TX Enhanced Shared Memory field allows the localbuffer to be shared with another device or both Localbuffer and Framebuffer to be shared with another device.

If two GLINT 500TX devices are to be used in a shared Framebuffer configuration, both will load the configuration resistors FBReset 11 and 12 into the FBModesel register. The SFBModeSwap field is used to force one device to be Primary controller and the other to be secondary controller as follows:-

The SFBMode is set to 2 using the Configuration resistors.

The GLINT500TX to be primary controller has the TXEnhanced pin pulled high. This enables the SFBModeSwap field to be set through FBReset bit 21.

The device to be secondary controller has the TXEnhanced pin grounded. This device will not load the SFBModeSwap field.

Table 7-4. Shared Memory Configuration

SFBSwap	TXEnhanced Shared Memory	SFB Mode Bits	Framebuffer Configuration	Localbuffer Configuration
X	0	0	Not Shared	Not Shared
0	0	1	Primary Controller	Not Shared
0	0	2	Secondary Controller	Not Shared
X	0	3	Secondary Controller	Secondary Controller
X	1	0	Not Shared	Not Shared
0	1	1	Not Shared	Primary Controller
0	1	2	Not Shared	Secondary Controller
X	1	3	Primary Controller	Primary Controller
1	0	1	Secondary Controller	Not Shared
1	0	2	Primary Controller	Not Shared
1	1	1	Not Shared	Secondary Controller
1	1	2	Not Shared	Primary Controller

The SFB interface consists of three signals, FBReq, FBGnt, and FBSelOEN. FBReq and FBGnt are used to arbitrate for the memory bus. FBSelOEN is used by the SFB slave to

indicate when it is controlling the bus. This can be used to enable buffers on the memory control lines if they are used.

Note - When GLINT 500TX is in enhanced mode, the FBSeIOEN pin is re-used to generate SOE2.

A primary controller is responsible for Memory refresh, VRAM transfer cycles(when it is the Framebuffer being shared) and arbitration of memory access requests from the secondary controller.

A secondary controller requests the memory bus whenever it requires a memory access. It will be granted the bus after an arbitrary amount of time. It keeps the bus until its grant is removed when it must vacate the bus within a defined period of time.

The shared Framebuffer control pins change function dependent on whether GLINT is a primary or secondary controller.

Table 7-5. Primary Controller Signals

Name	Width	Source	Description
FBReqN	1	I	Request from External secondary controller
FBGntN	1	O	Bus Grant to External secondary controller

Table 7-6. Secondary Controller Signals

Name	Width	Source	Description
FBReq	1	O	Request to External Primary Controller
FBGnt	1	I	Bus Grant from External Primary Controller
FBSeIOEN	1	O	Bus control output enable signal. (When TXEnhanced = 0)

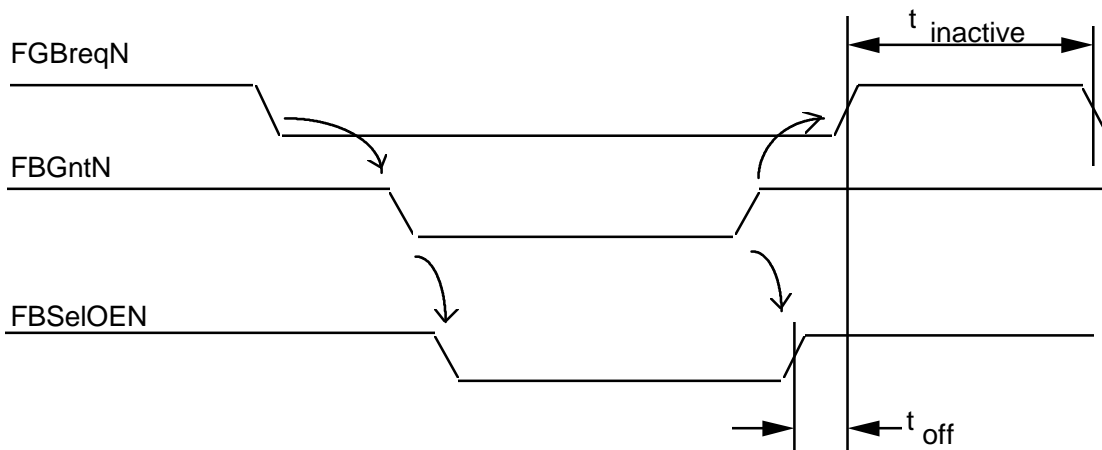

Figure 7-4. Shared Framebuffer Control Signals

7.3.1 GLINT 500TX as Primary Controller

FBReqN is internally resynchronised to MClk.

FBGntN is asserted an unspecified amount of time after FBReqN is asserted. The Framebuffer Address, Data and Control lines are tri-stated by the GLINT 500TX. The

Control lines are held high by external pull-up resistors. The secondary controller is now free to drive the Framebuffer lines and access the memory.

FBGntN remains asserted until the GLINT 500TX requires a Framebuffer access, or a refresh or transfer cycle.

When FBGntN is removed, the secondary controller must relinquish the address, data and control bus in a graceful manner - i.e. RasN, CasN, WEN and OEN must all be driven high before being tri-stated. DSF must be driven low before tri-state.

The secondary controller must relinquish the bus and negate FBReqN within 500ns of FBGntN being negated.

Once FBReqN has been negated, it must remain inactive for at least 2 system clocks. i.e. 40ns at 50 MHz.

FBReqN can be negated while FBGntN is still asserted. In this case, FBReqN cannot be re-asserted until at least 2 MClks after FBGntN has been negated.

In order to allow some control of the arbitration between primary and secondary controller, two programmable timeout fields are provided. in the Framebuffer TX Shared Memory Control register. The Primary Timeout field determines the number of clocks the primary controller will keep the bus and ignore requests from the secondary controller.

The Secondary timeout controller determines the number of clocks the secondary controller will be granted to bus before it will be forced to back off. This timeout count is ignored if the Primary Controller needs to perform either a refresh cycle, VRAM Transfer Cycle or a Bypass memory access. In these cases, the Secondary Controller is degraded the bus immediately.

The optimal setting for the fields will be system performance dependent. Similar numbers for each field will give approx. equal access to the bus to both controller, with the Primary controller having slightly more bandwidth because of priority access for refresh and transfers.

7.3.2 GLINT 500TX as Secondary Controller

Framebuffer Refresh and VRAM transfer cycles by the GLINT 500TX are turned off when it is a secondary Framebuffer controller.

The GLINT 500TX asserts FBReqN whenever it requires a Framebuffer access.

FBGntN is internally resynchronised to MClk.

When FBGntN is asserted and the TXEnhanced pin is pulled low, the GLINT 500TX drives FBselOEN to enable any external buffers used to drive the control signals, and then drives the Framebuffer address, data and control lines to perform the memory access.

When FBGntN is negated, The GLINT 500TX finishes any outstanding memory cycles, drives the control lines inactive, negates FBselOEN and then tri-states the Address, Data and Control lines, and then releases FBReqN. FBReqN is guaranteed to be released within 500ns of FBGntN being negated.

The GLINT 500TX will not reassert FBReqN within 4 system clock cycles. i.e. 80ns @ 50mhz.

GLINT 500TX will also tri-state the Address, Data and Control lines and remove FBReqN while FBGntN is still asserted if no memory accesses are required. In the Case, it waits for FBGntN to be removed before FBReqN is reasserted.

7.3.3 Shared Framebuffer Control at Reset

While the GLINT 500TX is in reset, both FBReqN and FBGntN are tri-stated.

7.3.4 Shared Framebuffer and VRAM DSF

The S3 shared Framebuffer interface protocol does not include the VRAM DSF signal. The GLINT 500TX has different performance to the GLINT 300SX in that DSF is a shared signal. The DSF lines are driven low and then tri-stated when control of the bus is relinquished by the GLINT 500TX as either a primary or a secondary controller.

7.4 Framebuffer Timing

There are 3 parameters which can be varied to affect the Framebuffer interface timings. These are the RAS-PRECHARGE, RAS-CAS-low and CAS-low fields of the Framebuffer memory control register.

RAS-PRECHARGE allows the RAS precharge time to be varied between 2 and 5 MClks.

RAS-CAS-low allows the time from RAS assertion to CAS assertion to be varied from 2 to 5 MClks.

CAS-low allows the CAS low time to be varied from 1 to 4 MClks.

Table 9-13 in the Electrical Data section shows how the memory timings are affected by varying these parameters.

7.5 VRAM Requirements

The GLINT 500TX requires VRAM that support CAS-before-RAS refresh. It can make use of VRAM block fill modes. Both 4 column and 8 column block fill devices are supported.

If the internal timing generator is being used to generate the display, the VRAM must support both full read transfers and split read transfers. The shift register size can be either 256 or 512 elements long - so a split transfer loads either 128 or 256 elements respectively. Split transfers with a stop address are not supported, but devices that support this feature can be used.

7.6 External Timing Generator

If an external timing generator is used with the GLINT 500TX, then the control of the VRAM must be shared between the GLINT 500TX and the timing generator. In general, the GLINT 500TX controls the VRAM random port and the Timing Generator controls the VRAM serial port. However, the VRAM serial shift register must be loaded using the VRAM random port. Co-ordination between the timing generator and the GLINT 500TX

is used to achieve this operation. The timing generator requests a VRAM transfer cycle from GLINT and provides the transfer address with the GLINT 500TX performing the actual VRAM access. An example circuit is shown below.

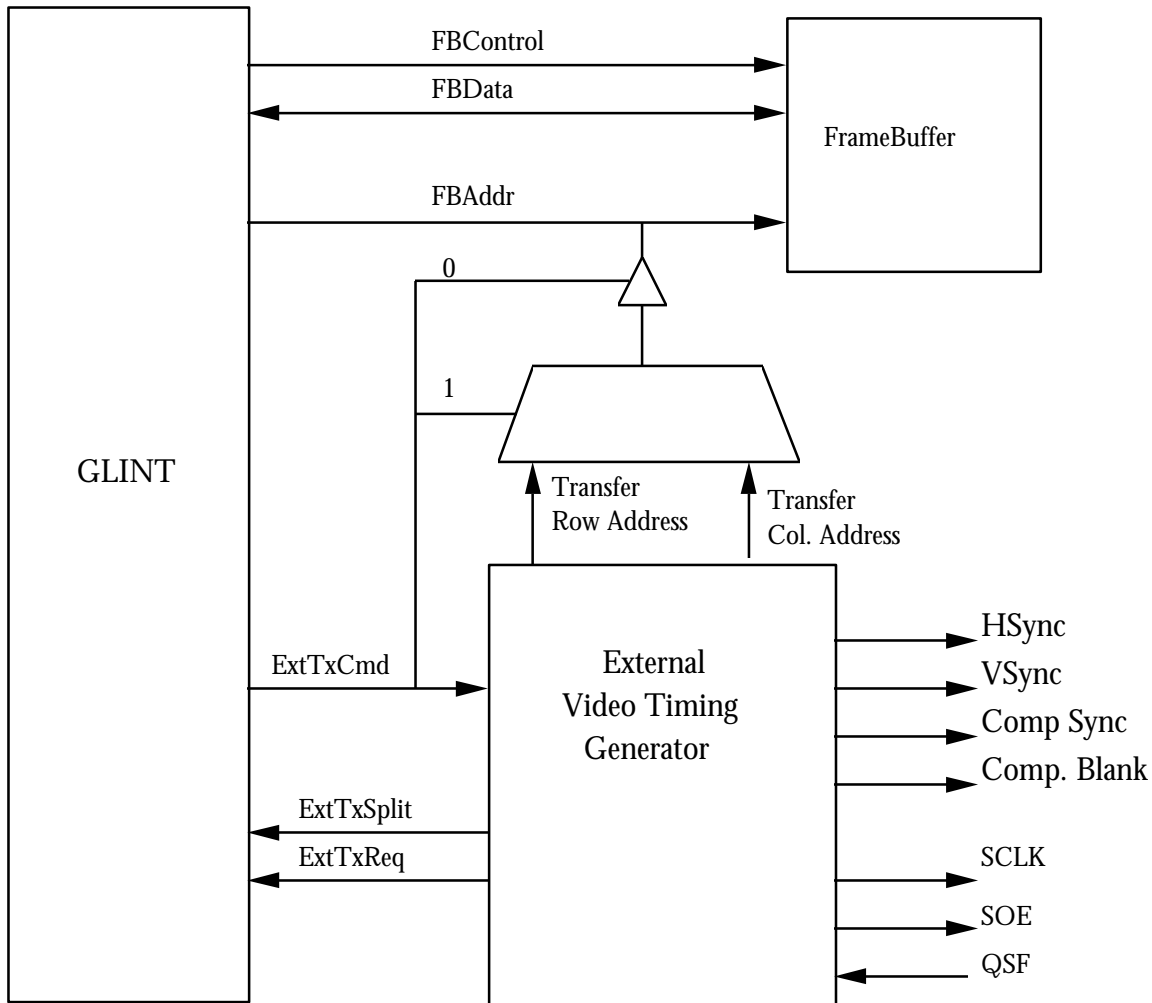

Figure 7-5 External Timing Generator Interface

An external controller requests a VRAM transfer cycle by asserting ExtTxReq and setting ExtTxSplit to indicate whether a split transfer or full transfer is required. This is internally resynchronised to MClk. When any outstanding memory access is complete GLINT tri-states the FBAddr bus. ExtTXCmd is set to 1 and the external controller should drive the transfer row address onto the bus. When ExtTxCmd is set to 3, the external controller should drive the transfer column address onto the bus. ExtTxReq must be asserted until ExtTxCmd is set to 2 indicating the transfer is complete. When ExtTxReq is negated by the external controller then ExtTXCmd returns to 0. It is intended that ExtTXCmd bit 0 is a direct output enable control onto FBAddr bus with ExtTXCmd bit 1 as a row/column select line.

The row address should be asserted within 20ns of ExtTxCmd = 1.

The column address should be asserted within 20ns of ExtTxCmd = 3.

The external controller should tri-state the FBAddr bus within 20ns of ExtTxCmd = 2 and when ExtTxCmd = 0.

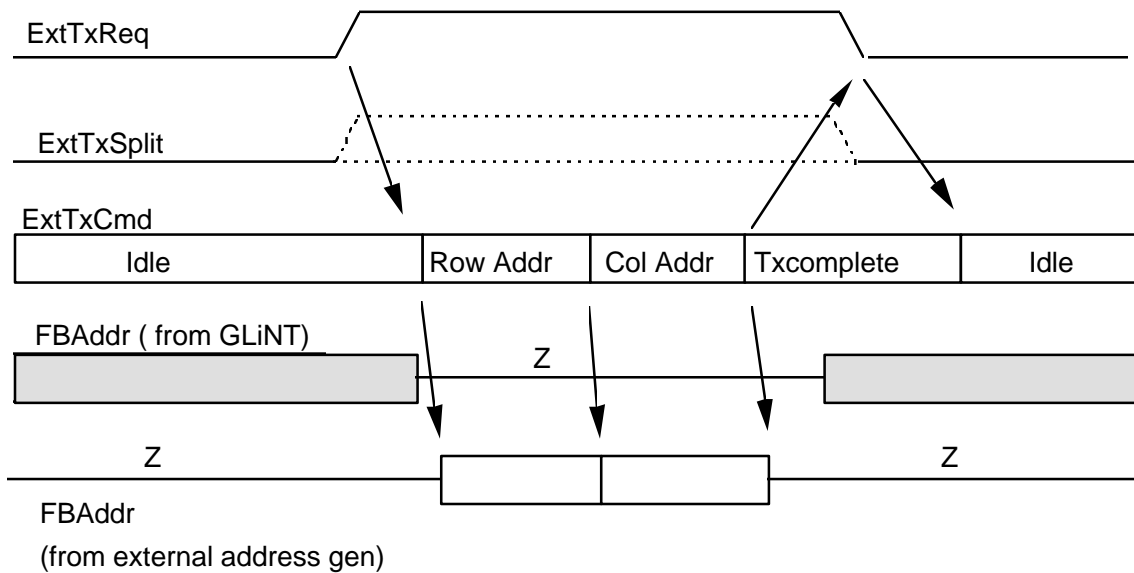

Figure 7-6 Transfer Request Protocol

The Ext. Timing field of the FB_MODE_SELECT register determines whether the internal or an external timing generator is used.

Ext. Timing

0 = Internal Timing Generator

1 = External Timing Generator

The following GLINT 500TX pins have dual function depending on whether an internal or external timing generator is used.

Table 7-7. Timing Generator Pins

Pin Name	Internal VTG function	Direction	External VTG function	Direction
QSF/TXReq	QSF	I	ExtTxReq	I
CBlank/Split	CompBlank	O	ExtTxSplit	I
HSync/Cmd1	HSync	O	ExtTxCmd1	O
VSynC/Cmd0	VSynC	O	ExtTxCmd0	O

7.7 Framebuffer Configurations

The Framebuffer consists of a number of 64 bit banks of memory. These can be configured in a number of ways. In particular they may be one, two or four way interleaved. The interleave chosen depends on the total amount of memory to be fitted, the pixel port width of the LUT-DAC used and the maximum resolution that needs to be supported. Table 7-7 below shows how the Framebuffer control lines are decoded with different interleaving schemes in Dual-Cas mode.

The Cas lines are used as byte enables for memory accesses.

The Write Enable and Output Enable control lines FBMemWeN(3:0) and FBMemOeN(3:0) are decoded from the address bits marked E1 and E0 below. These signals perform the bank interleaving.

The FBMemRasN(3:0) lines are decoded from the address bits marked R1 and R0 below.

One Way interleave mode only uses FBMemWeN(0) and FBMemOeN(0). Address bit 21 (marked RX below) decodes either FBMemRasN(0) or FBMemRasN(2) .

In addition to the three standard interleaves, two ‘S3 Compatible’ modes are provided. These are set up by setting the S3 Compatible field of the Framebuffer TX shared memory control register (together with the appropriate Framebuffer Interleave).

One way interleaved S3 compatible mode uses Address bit 21 to select between WE/OE 1 and WE/OE 0. Address bits 23 and 22 are decoded to select between FBMemRasN(3), (2), (1) and (0).

Two way interleaved S3 Compatible mode uses Address bits 23 and 3 to decode WE/OE 3 ,2,1 and 0 . Address bits 24 and 22 are used to decode FBMemRasN(3), (2), (1) and (0).

Note that although the maximum address range for the Framebuffer is 32 Mbytes, the Graphics core can only generate pixel addresses up to 16 Mpixels. In 32bpp and 16 bpp modes this is sufficient to address the whole Framebuffer range. In 8bpp mode, only the lower 16Mbytes of Framebuffer can be addressed from the graphics core.

Table 7-8. Framebuffer Addressing in Dual-CAS Mode.

	Address Bits																											
	24	23	22	21	20	19	18	17	16	15	14	13	12	11	10	9	8	7	6	5	4	3	2	1	0			
1 way interleaved	X	X	X	R X	Row Address									Column Address									Cas 7:0					
2 way interleaved	R1	R0	E1	Row Address									Column Address									E0	Cas 7:0					
4 way interleaved	R1	R0	Row Address									Column Address									E1	E0	Cas 7:0					
1way interleaved S3	X	R1	R0	E0	Row Address									Column Address									Cas 7:0					
2 way interleaved S3	R1	E1	R0	Row Address									Column Address									E0	Cas 7:0					

8. GLINT 500TX Register Set

Table 8-1. GLINT 500TX Configuration Region Registers

Register	Type	Offset	Section	Description
----------	------	--------	---------	-------------

Device Identification

CFGVendorId	R	00h	2.1.1	Vendor identification number
CFGDeviceID	R	02h	2.1.2	Device identification number
CFGRevisionID	R	08h	2.1.3	Revision identification number
CFGClassCode	R	09h	2.1.4	Class code register
CFGHeaderType	R	0Eh	2.1.5	Header type

Device Control/Status

CFGCommand	R/W	04h	2.2.1	PCI command register
CFGStatus		06h	2.3.1	PCI status register

Miscellaneous Functions

CFGBist	R	0Fh	2.4.1	BIST
CFGLatTimer	R/W	0Dh	2.4.2	Latency timer value
CFGCacheLine	R	0Ch	2.4.3	Cache line size
CFGMaxLat	R	3Fh	2.4.4	Maximum latency period
CFGMinGrant	R	3Eh	2.4.5	Minimum grant period
CFGIntPin	R	3Dh	2.4.6	Interrupt pin being used
CFGIntLine	R/W	3Ch	2.4.7	Interrupt line routing information

Base Addresses

CFGBaseAddr0	R/W	10h	2.5.1	Control space offset
CFGBaseAddr1	R/W	14h	2.5.2	Aperture 0 Localbuffer offset
CFGBaseAddr2	R/W	18h	2.5.3	Aperture 0 Framebuffer offset
CFGBaseAddr3	R/W	1Ch	2.5.4	Aperture 1 Localbuffer offset
CFGBaseAddr4	R/W	20h	2.5.5	Aperture 1 Framebuffer offset
CFGRomAddr	R/W	30h	2.5.6	Expansion ROM offset

Table 8-2. GLINT 500TX Region 0 Registers

Register	Type	Offset	Section	Description
----------	------	--------	---------	-------------

Control Status Registers

ResetStatus	R/W	0000h	3.1.1	Reset status and software reset
IntEnable	R/W	0008h	3.1.2	Interrupt enable
IntFlags	R/W	0010h	3.1.3	Interrupt flags
InFIFOSpace	R	0018h	3.1.4	Input FIFO space
OutFIFOWords	R	0020h	3.1.5	Number of words in the output FIFO
DMAAddress	R/W	0028h	3.1.6	DMA start address
DMACount	R/W	0030h	3.1.7	DMA word count
ErrorFlags	R/W	0038h	3.1.8	Error flags
VClkCtl	R/W	0040h	3.1.9	Video clock control
TestRegister	R/W	0048h	3.1.10	Test register (Diagnostic)
Aperture0	R/W	0050h	3.1.11	Aperture 0 control
Aperture1	R/W	0058h	3.1.12	Aperture 1 control
DMAControl	R/W	0060h	3.1.13	DMA control
FIFODis	R/W	0068h	3.1.14	FIFO Disconnect

Localbuffer Registers

LBMemoryCtl	R/W	1000h	3.2.1	Localbuffer memory control register
LBMemoryEDO	R/W	1008h	3.2.2	Localbuffer EDO memory control

Framebuffer Registers

FBMemoryCtl	R/W	1800h	3.3.1	Framebuffer memory control register
FBModeSel	R/W	1808h	3.3.2	Framebuffer mode select
FBGCWrMask	R	1810h	3.3.3	Framebuffer GC write mask (Diagnostic)
FBGCCColorLower	R	1818h	3.3.4	Framebuffer GC color lower (Diagnostic)
FBTXMemCtl	R/W	1820h	3.3.5	Framebuffer TX Shared Memory Control
FBWrMask	R/W	1830h	3.3.6	Framebuffer Bypass Write mask
FBGCCColorUpper	R/W	1838h	3.3.7	Framebuffer GC color upper (Diagnostic)

Register	Type	Offset	Section	Description
----------	------	--------	---------	-------------

Internal Video Registers

VTGHLimit	R/W	3000h	4.2.1	Horizontal VClk count limit
VTGHSyncStart	R/W	3008h	4.2.2	Horizontal sync pulse start
VTGHSyncEnd	R/W	3010h	4.2.3	Horizontal sync pulse end
VTGHBlankEnd	R/W	3018h	4.2.4	Horizontal blanking period end
VTGVLimit	R/W	3020h	4.2.5	Vertical line count limit
VTGVSyncStart	R/W	3028h	4.2.6	Vertical sync pulse start
VTGVSyncEnd	R/W	3030h	4.2.7	Vertical sync pulse end
VTGVBlankEnd	R/W	3038h	4.2.8	Vertical blanking period end
VTGHGateStart	R/W	3040h	4.2.9	Horizontal gate pulse start
VTGHGateEnd	R/W	3048h	4.2.10	Horizontal gate pulse end
VTGVGateStart	R/W	3050h	4.2.11	Vertical gate pulse start
VTGVGateEnd	R/W	3058h	4.2.12	Vertical gate pulse end
VTGPolarity	R/W	3060h	4.2.13	Output signal polarity control
VTGFrameRowAddr	R/W	3068h	4.2.14	Frame row address
VTGVLineNumber	R	3070h	4.2.15	Vertical line number
VTGSerialClk	R/W	3078h	4.2.16	Serial clock control
VTGModeCtl	R/W	3080h	4.2.17	Mode Control

9. Electrical Data

9.1 Absolute Minimum/Maximum Ratings

Table 9-1 Absolute Minimum/Maximum Ratings

Junction Temperature	100°C
Storage Temperature	-65°C to 150°C
Minimum Operating Temperature	0°C
DC Supply Voltage	3.8V
I/O Pin Voltage with respect to GND	-0.5V to 5.5V

9.2 DC Specifications

Table 9-2 DC Specifications

Symbol	Parameter	Min	Max	Unit
VDD	Supply Voltage	3.0	3.6	V
LPIN	Pin Inductance		18.4	nH
ICC	Power Supply Current		740	mA

Table 9-3 PCI Signal DC Specifications

Symbol	Parameter	Min	Max	Unit
VPIL	Input Low Voltage		0.8	V
VPIH	Input High Voltage	2.0		V
VPOL	Output Low Voltage		0.5	V
VPOH	Output High Voltage	2.4		V
IPIL	Input Low Current		-25	uA
IPIH	Input High Current		25	uA
CPIN	Input Capacitance		10	pF
CCLK	PCI Clock Input Capacitance		10	pF
CIDSEL	PCI Idsel Input Capacitance		10	pF

Table 9-4 Non PCI Signal DC Specifications

Symbol	Parameter	Min	Max	Unit
V _{IL}	Input Low Voltage		0.8	V
V _{IH}	Input High Voltage	2.0		V
V _{OL}	Output Low Voltage		0.5	V
V _{OH}	Output High Voltage	2.4		V
I _{OL12}	Output Low Current	12		mA
I _{OH12}	Output High Current	-8		mA
I _{OL8}	Output Low Current	8		mA
I _{OH8}	Output High Current	-6		mA
I _{IL}	Input Low Current		1	uA
I _{IH}	Input High Current		1	uA
I _{IHPD}	Pulldown Input High Current		250	uA
I _{I LPU}	Pullup Input Low Current		250	uA
C _{IN}	Input Capacitance		10	pF

9.3 AC Specifications

Table 9-5 Test Loads For AC Timing

Pin Name	Capacitive Load
PCIAD[31:0], PCICBEN[3:0], PCIPar, PCIFrameN, PCIIRdyN, PCITRdyN, PCIStopN, PCII dsel, PCIDevselN, PCIReqN, PCIGntN, PCIIIntAN, LBMemAddr[11:0], LBRasN[1:0], LBCasN[5:0], LBMemOeN[1:0], LBMemWeN, LBMemData[47:0], FBMemAddr[8:0], FBMemRas[3:0], FBMemCas[7:0], FBMemOeN[3:0], FBMemWeN[3:0], FBMemDSF[1:0], FBMemData[63:0], LDClk, SClk[1:0], SOE[3:0].	50pF
CompSync, DacWrN, DacRdN, HSync/ExtTxCmd[0], VSync/ExtTxCmd[1], CBlank/ExtTxSplit, FBGnt, FBReq, FBSeIOE, VClkCtl[1:0], RomEnN.	20pF

9.3.1 Clock Timing

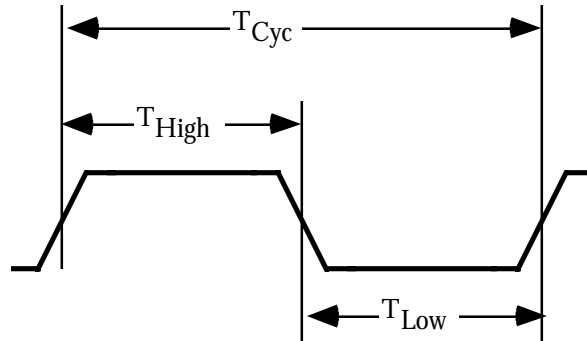

Figure 9-1 Clock Waveform Timing

Table 9-6 Clock Waveform Timing

Symbol	Parameter	Min	Max	Units	Notes
T_{PCyc}	PCIClk Cycle Time	30		nS	
T_{PHigh}	PCIClk High Time	8		nS	
T_{VLow}	PCIClk Low Time	8		nS	
T_{MCyc}	MClk Cycle Time	25	40	nS	
T_{MHigh}	MClk High Time	8		nS	
T_{MLow}	MClk Low Time	8		nS	
T_{VCyc}	VClk Cycle Time	20		nS	
T_{VHigh}	VClk High Time	6		nS	
T_{VLow}	VClk Low Time	6		nS	

9.3.1 Input / Output Timing

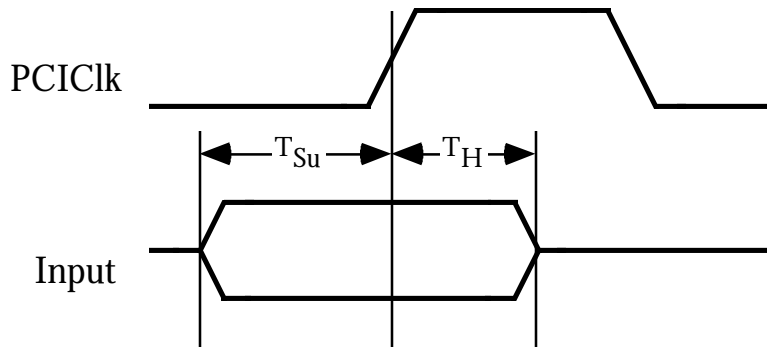

Figure 9-2 PCIClk Referenced Input Timing

Table 9-7 PCIClk Referenced Input Timing

Parameter	T _{Su} Min	T _H Min	Units	Notes
PCIAD(31:0), PCICBEN(3:0), PCIPar, PCIFrameN, PCIIRdyN, PCITRdyN, PCIStopN, PCIIdsel, PCIDevselN	7	0	nS	
PCIGntN	10	0	nS	
PCIRstN	7	0	nS	1

Notes:

- 1 PCIRstN is resynchronised internally. The timings given, when met, ensure that the reset is detected in the current cycle.

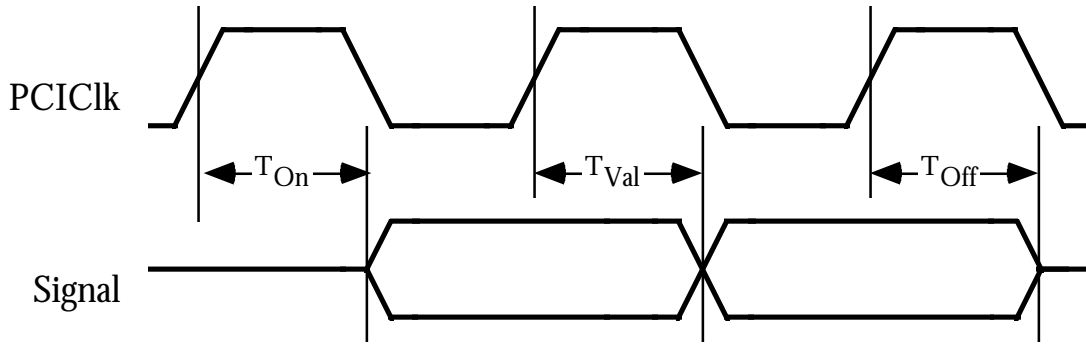

Figure 9-3 PCIClk Referenced Output Timing

Table 9-8 PCIClk Referenced Output Timing

Parameter	TVal		TOn		TOff		Units	Notes
	Min	Max	Min	Max	Min	Max		
PCIAD(31:0), PCICBEN(3:0), PCIPar, PCIFrameN, PCIIRdyN, PCITRdyN, PCIStopN, PCIIdsel, PCIDevselN	2	11	2	11	2	11	nS	
PCIReqN	2	12					nS	
PCIIntAN	2	11					nS	1

Notes:

1. Timings given are for falling edges of the open drain signal. Rise times are dependent on the external pull-up resistor.

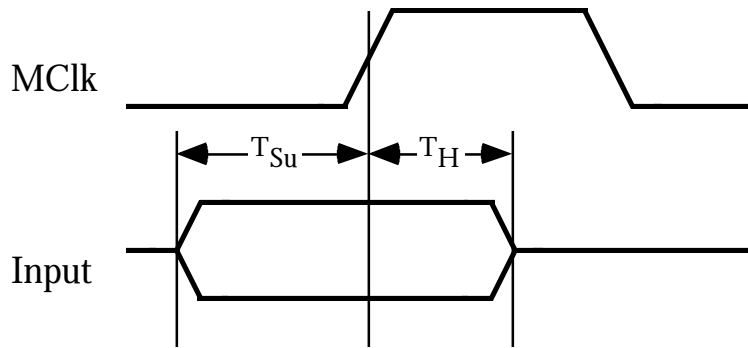

Figure 9-4 MClk Referenced Input Timing

Table 9-9 MClk Referenced Input Timing

Parameter	T_{Su} Min	T_H Min	Units	Notes
FBReqN	-	-	nS	1
FBGntN	-	-	nS	2
QSF/ExtTxReq	-	-	nS	3
CBlank/ExtTxSplit	-	-	nS	3
ExtIntN	5	2	nS	4

Notes:

1. This signal is an input when GLINT 500TX is a Shared Framebuffer Primary Controller. It is resynchronised internally.
2. This signal is an input when GLINT 500TX is a Shared Framebuffer Secondary Controller. It is resynchronised internally.
3. These signals are inputs when GLINT 500TX has an external video timing controller. These are resynchronised internally.
4. ExtIntN is resynchronised internally. The timings given ensure that the interrupt is detected in the current cycle.

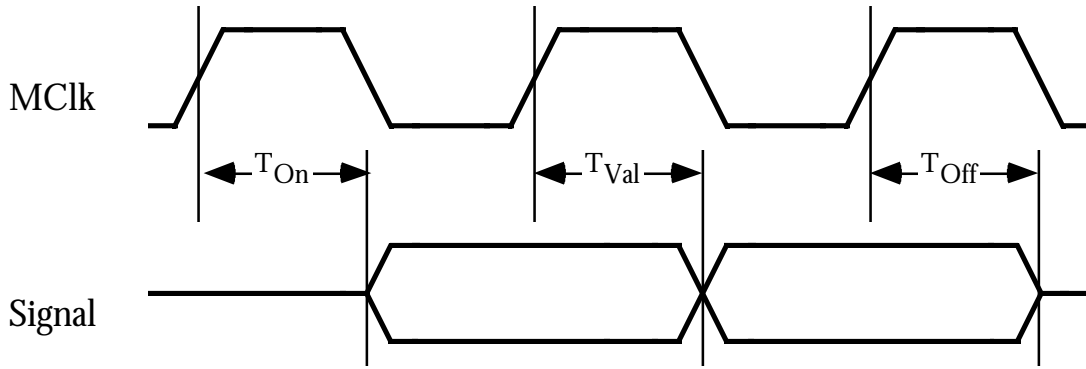

Figure 9-5 MClk Referenced Output Timing

Table 9-10 MClk Referenced Output Timing

Parameter	TVal		TOn		TOff		Units	Notes
	Min	Max	Min	Max	Min	Max		
LBMemAddr(11:0)	7	23	-	-	-	-	nS	
LBMemRasN(1:0)	5	17					nS	
LBMemCasN(5:0)	5	17					nS	
LBMemOeN(1:0)	5	17					nS	
LBMemWeN(1:0)	5	17					nS	
LBMemData(63:0)	5	20	7	20	7	20	nS	
FBMemAddr(8:0)	7	25	5	25	5	15	nS	
FBMemRasN(3:0)	5	16	5	17	5	17	nS	
FBMemCasN(7:0)	5	17	5	17	5	17	nS	
FBMemOeN(3:0)	5	17	5	17	5	17	nS	
FBMemWeN(3:0)	5	17	5	17	5	17	nS	
FBMemDSF(1:0)	5	17	5	17	5	17	nS	
FBMemData(63:0)	6	24	7	27	7	27	nS	
FBReq	7	25					nS	
FBGnt	7	25					nS	
FBSelOEN	6	20					nS	
HSync/ExtTxCmd1	7	24					nS	
VSynC/ExtTxCmd0	7	24					nS	
DacWrN	5	20					nS	
DacRdN	5	20					nS	
RomEnN	5	20					nS	

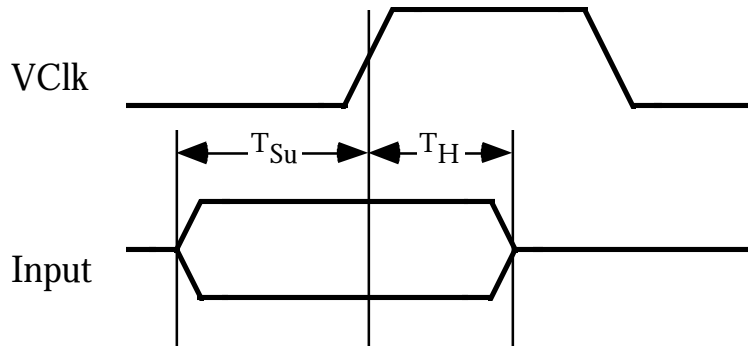

Figure 9-6 VClk Referenced Input Timing

Table 9-11 VClk Referenced Input Timing

Parameter	T_{Su} Min	T_H Min	Units	Notes
QSF/ExtTxReq	3	3	nS	1

Notes:

1. QSF/ExtTxReq is only timed against VClk when the GLINT 500TX is set to use the internal timing generator.

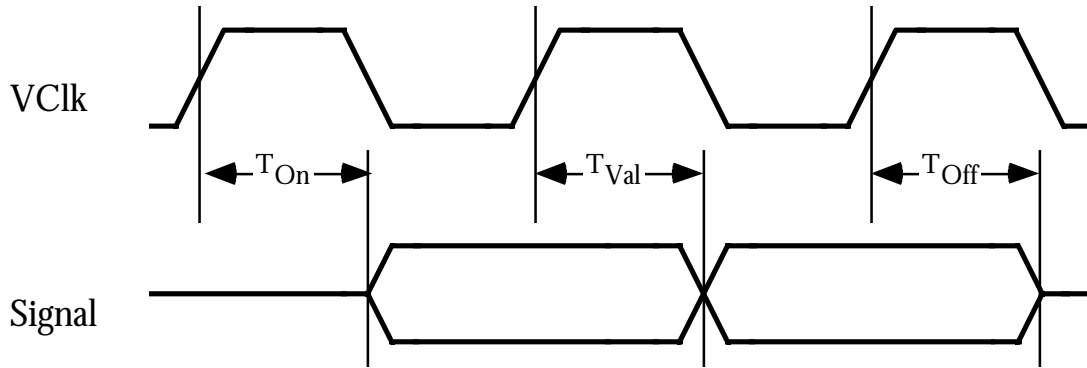

Figure 9-7 VClk Referenced Output Timing

Table 9-12 VClk Referenced Output Timing

Parameter	T_{Val}		T_{On}		T_{Off}		Units	Notes
	Min	Max	Min	Max	Min	Max		
Sclk(1:0)	4.5	15					nS	
SOE(3:0)	4.5	19					nS	
LDClk	4	15					nS	
CBlank/ExtTxSplit	7	21					nS	1
HSync/ExtTxCmd1	7	21					nS	1
VSynC/ExtTxCmd0	7	21					nS	1
CompSync	7	21					nS	

Notes:

1. These signals are only timed against VClk when the GLINT 500TX is set to use the internal timing generator.

File Name : glintfbrd.ps
Creator : timing v1.2 (simon.moore@3dlabs.com)
Pages : 1

Figure 9-8 Framebuffer Read Timings

File Name : glintfbwr.ps
Creator : timing v1.2 (simon.moore@3dlabs.com)
Pages : 1

Figure 9-9 Framebuffer Write Timing

File Name : glintfbtr.ps
Creator : timing v1.2 (simon.moore@3dlabs.com)
Pages : 1

Figure 9-10 Framebuffer Transfer Cycle Timing

File Name : glintfbctr.ps
Creator : timing v1.2 (simon.moore@3dlabs.com)
Pages : 1

Figure 9-11 Framebuffer CAS-Before-RAS Refresh Timings

Table 9-13 Framebuffer Timing

Symbol	Parameter	Nominal timing in system clocks	Nominal timing at 50MHz
t_{cas}	CAS Pulse Width	CL	$20 * CL$
t_{crp}	CAS to RAS Precharge	CL	$20 * CL$
t_{csh}	CAS hold time	RL+CL	$20 * (RL+CL)$
t_{pc}	Page-mode cycle time	CL + 1	$20 * (CL+1)$
t_{cp}	CAS Precharge time	1	20
t_{rp}	RAS Precharge time	RP	$20 * RP$
t_{rc}	Random read /write Cycle time	RL + RP+CL	$20 * (RL+RP+CL)$
t_{ras}	RAS pulse Width	RL+CL	$20 * (RL+CL)$
t_{rcd}	RAS to CAS delay time	RL+CL	$20 * (RL+CL)$
t_{rah}	Row Address hold time	1	20
t_{ar}	Column address Hold time (referenced to RAS)	RL+CL	$20 * (RL+CL)$
t_{asc}	Column Address setup time	1	20
t_{cah}	Column Address Hold time	CL	$20 * CL$
t_{wch}	Write Command hold time	1	20
t_{wcr}	Write Command hold time (referenced to RAS)	RL+CL	$20 * (RL+CL)$
t_{wp}	Write Command pulse width	CL	$20 * CL$
t_{ds}	Data setup time	1	20
t_{dh}	Data hold time	CL	$20 * CL$
t_{dhr}	Data hold time (to RAS)	RL+CL	$20 * (RL+CL)$
t_{rpc}	RAS precharge to CAS active	1	20
t_{csr}	CAS setup time for CAS-before-RAS refresh	1	20
t_{chr}	CAS hold time for CAS-before-RAS refresh	RL+CL	$20 * (RL+CL)$
t_{asr}	Row Address setup time	1	20
t_{tls}	DT/OE setup time to RAS	1	20
t_{tlh}	DT/OE hold time to RAS	1	20
t_{fsc}	DSF setup time referenced to CAS	1	20
t_{cfh}	DSF hold time (to CAS)	CL	$20 * CL$
t_{fsr}	DSF setup time referenced to RAS	1	20
t_{rfh}	DSF hold time referenced to RAS	1	20

t_{tp}	DT/OE Precharge time	1	20
t_{trp}	DT/OE to RAS Precharge time	RP + 2	20*(RP+2)

The following table gives the access times required to read from VRAM into the GLINT 500TX.

A CAS access time of 15ns or better is required for a system clock of 50MHz with the CAS-low parameter set to 1 clock.

Table 9-14. VRAM Access Time Requirements.

Symbol	Parameter	Nominal timing in system clocks	Nominal timing at 50MHz
t_{cpa}	Access time from CAS Precharge	CL + 1	$20*(CL+1) - 5$
t_{rac}	Access time from RAS	RL+CL	$20*(RL+CL) - 5$
t_{cac}	Access time from CAS	CL	$20*CL - 5$
t_{oea}	Access time from OE	CL	$20*CL - 5$
t_{caa}	Access time from Column Address	CL + 1	$20*(CL+1) - 5$

File Name : glintlbrd.ps
 Creator : timing v1.2 (simon.moore@3dlabs.com)
 Pages : 1

Figure 9-12 Localbuffer Read Timings - Fast-Page Mode

File Name : glintlbwr.ps
Creator : timing v1.2 (simon.moore@3dlabs.com)
Pages : 1

Figure 9-13 Localbuffer Write Timings - Fast-Page Mode

File Name : glintlbcbr.ps
Creator : timing v1.2 (simon.moore@3dlabs.com)
Pages : 1

Figure 9-14 Localbuffer CAS-Before-RAS Refresh Timings

Table 9-15 Localbuffer Timing - Fast-page mode

Symbol	Parameter	Nominal timing in system clocks	Nominal timing at 50MHz
t_{cas}	CAS Pulse Width	CL	$20 * CL$
t_{crp}	CAS to RAS Precharge	CL	$20 * CL$
t_{csh}	CAS hold time	RL+CL	$20 * (RL+CL)$
t_{pc}	Page-mode cycle time	CL + 1	$20 * (CL+1)$
t_{cp}	CAS precharge time	1	20
t_{rp}	RAS precharge time	RP	$20 * RP$
t_{rc}	Random read or write Cycle time	RL + RP+CL	$20 * (RL+RP+CL)$
t_{ras}	RAS pulse Width	RL+CL	$20 * (RL+CL)$
t_{rcd}	RAS to CAS delay time	RL+CL	$20 * (RL+CL)$
t_{rah}	Row Address hold time	1	20
t_{ar}	Column address Hold time (referenced to RAS)	RL+CL	$20 * (RL+CL)$
t_{asc}	Column Address setup time	1	20
t_{cah}	Column Address Hold time	CL	$20 * CL$
t_{wch}	Write Command hold time	1	20
t_{wcr}	Write Command hold time (referenced to RAS)	RL+CL	$20 * (RL+CL)$
t_{wp}	Write Command pulse width	CL	$20 * CL$
t_{ds}	Data setup time	1	20
t_{dh}	Data hold time	CL	$20 * CL$
t_{dhr}	Data hold time (referenced to RAS)	RL+CL	$20 * (RL+CL)$
t_{rpc}	RAS precharge to CAS active	1	20
t_{csr}	CAS setup time for CAS-before-RAS refresh	1	20
t_{chr}	CAS hold time for CAS-before-RAS refresh	RL+CL	$20 * (RL+CL)$
t_{asr}	Row Address setup time	1	20

The following table gives the access times required to read from DRAM into the GLINT 500TX.

A CAS access time of 15ns or better is required for a system clock of 50MHz with the CAS-low parameter set to 1 clock.

Table 9-16. Localbuffer Access Time Requirements - Fast Page Mode.

Symbol	Parameter	Nominal timing in system clocks	Nominal timing at 50MHz
t_{cpa}	Access time from CAS precharge	CL + 1	$20*(CL+1) - 5$
t_{rac}	Access time from RAS	RL+CL	$20*(RL+CL) - 5$
t_{cac}	Access time from CAS	CL	$20*CL - 5$
t_{oea}	Access time from OE	CL	$20*CL - 5$
t_{caa}	Access time from Column Address	CL + 1	$20*(CL+1) - 5$

<p>Title: Creator: timing v1.2 (simon.moore@3dlabs.com) CreationDate:</p>

Figure 9-15 Localbuffer Write Timings - EDO mode

Title:
Creator: timing v1.2 (simon.moore@3dlabs.com)
CreationDate:

Figure 9-16 Localbuffer Read Timings - EDO mode

Table 9-17 Localbuffer Timing - EDO mode

Symbol	Parameter	Nominal timing in system clocks	Nominal timing at 50MHz
t_{cas}	CAS Pulse Width	0.5	10
t_{crp}	CAS to RAS Precharge	1.5	30
t_{csh}	CAS hold time	RL+1	20*(RL+1)
t_{pc}	Page-mode cycle time	1	20
t_{cp}	CAS precharge time	0.5	10
t_{rp}	RAS precharge time	RP	20*RP
t_{rc}	Random read or write Cycle time	RL + RP+1	20*(RL+RP+1)
t_{ras}	RAS pulse Width	RL+1	20*(RL+1)
t_{rzd}	RAS to CAS delay time	RL+0.5	20*(RL+0.5)
t_{rah}	Row Address hold time	1	20
t_{ar}	Column address Hold time (referenced to RAS)	RL+CL	20*(RL+CL)
t_{asc}	Column Address setup time	1	20
t_{cah}	Column Address Hold time	0.5	10
t_{wch}	Write Command hold time	0.5	10
t_{wcr}	Write Command hold time (referenced to RAS)	RL+CL	20*(RL+CL)
t_{ds}	Data setup time	0.5	10
t_{dh}	Data hold time	0.5	10
t_{dhr}	Data hold time (referenced to RAS)	RL+1	20*(RL+1)
t_{rpc}	RAS precharge to CAS active	1	20
t_{csr}	CAS setup time for CAS-before-RAS refresh	1	20
t_{chr}	CAS hold time for CAS-before-RAS refresh	RL+CL	20*(RL+CL)
t_{asr}	Row Address setup time	1	20

The following table gives the access times required to read from DRAM into the GLINT 500TX.

A HyperPage Mode cycle time of 20ns or better is required for a system clock of 50MHz.

Table 9-18. Localbuffer Access Time Requirements - EDO Mode.

Symbol	Parameter	Nominal timing in system clocks	Nominal timing at 50MHz
t_{cpa}	Access time from CAS precharge	1.5	30
t_{rac}	Access time from RAS	RL+1.5	20*(RL+ 1.5)
t_{cac}	Access time from CAS	1	20
t_{oea}	Access time from OE	1.5	30
t_{caa}	Access time from Column Address	1.5	30

File Name : glintrom.ps
 Creator : timing v1.2 (simon.moore@3dlabs.com)
 Pages : 1

Figure 9-17 ROM Read Timings

Table 9-19. ROM Read Timings.

Symbol	Parameter	Nominal timing in system clocks	Nominal timing at 50MHz
t_{rom}	ROMEN low time	8	160 ns
t_{as}	Address setup time	1	20 ns
t_{ah}	Address hold time	1	20 ns

Table 9-20. ROM Access Times.

Symbol	Parameter	Nominal timing in system clocks	Nominal timing at 50MHz
t_{aa}	Access time from ROMEN	-	150 ns min.
t_{oez}	Access time from Column Address	-	20 ns min.

File Name : glintdacrd.ps
 Creator : timing v1.2 (simon.moore@3dlabs.com)
 Pages : 1

Figure 9-18 LUT-DAC Read Timings

File Name : glintdacwr.ps
 Creator : timing v1.2 (simon.moore@3dlabs.com)
 Pages : 1

Figure 9-19 LUT-DAC Write Timings

Table 9-21. LUT-DAC Timings.

Symbol	Parameter	Nominal timing in system clocks	Nominal timing at 50MHz
t_{rd}	DACRDN low time	8	160 ns
t_{as}	Address setup time	1	20 ns
t_{ah}	Address hold time	1	20 ns
t_{ds}	Data setup time	1	20 ns
t_{dh}	Data hold time	1	20 ns

Table 9-22. LUT-DAC Access Times.

Symbol	Parameter	Nominal timing in system clocks	Nominal timing at 50MHz
t_{aa}	Access time from DACRDN	-	150 ns min.
t_{oez}	Access time from Column Address	-	20 ns min.

10. Pin Information.

10.1 Package Pinout

The GLINT 500TX comes in a 304 pin QFP package. The pin numbering is shown in figure 10-1.

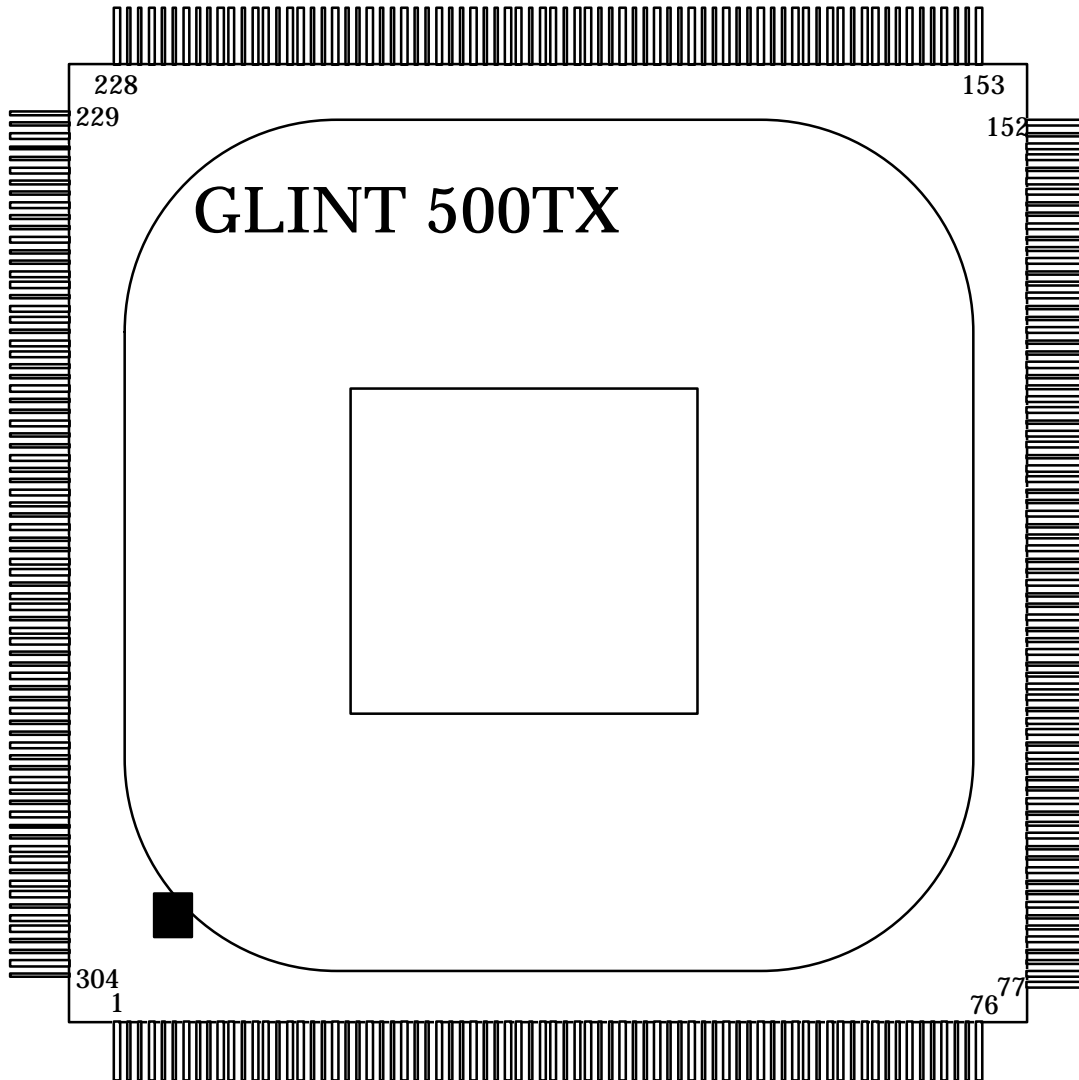

Figure 10-1 GLINT 500TX Pin Numbering

10.2 Pin Descriptions

Table 10-1 provides a brief description of each pin. The following pin type definitions are used.

I	Input signal
O	Output signal
I/O	Bi-directional signal

Output power ratings are marked as 4, 8, or 12 for the milliamp current rating or P indicating a PCI compatible output.

Table 10-1. Pin Descriptions

Symbol	Type	Power	Pin Number(s)	Description
--------	------	-------	---------------	-------------

Clocks

PCIClk	I		11	PCI clock.
MClk	I		262	System clock. Used for all internally clocked functions on the chip and by the memory controllers.
VClk	I		296	Video clock. Used by internal video rate circuitry. Typically connected to a divided pixel clock.
LDClk	O	12	304	LUT-DAC Load clock.

PCI Interface

PCIAD(31:0)	I/O	P	14-15, 17-22, 27-28, 30-32, 34-36, 51, 54-57, 59-61, 64-67, 73-76	PCI Address and Data bus.
PCICBEN(3:0)	I/O	P	23, 37, 50, 62	PCI command and bytes enables.
PCIPar	I/O	P	49	PCI parity bit.
PCIFrameN	I/O	P	40	PCI frame control line.
PCIIRdyN	I/O	P	41	PCI Initiator Ready.
PCITRdyN	I/O	P	42	PCI Target Ready.
PCIStopN	I/O	P	44	PCI Target Stop control.
PCIIdsel	I		26	PCI slot configuration select line.
PCIDevselN	I/O	P	43	PCI Target selected.
PCIReqN	O	P	13	PCI Master request line.
PCIGntN	I		12	PCI Master Grant line.
PCIFifoIndis	O	P	47	PCI Input Fifo Disconnect
PCIFifoOutDis	O	P	48	PCI OutputFifo Disconnect.
PCIIntAN	OD	P	5	PCI interrupt line.

Symbol	Type	Power	Pin Number(s)	Description
--------	------	-------	---------------	-------------

Localbuffer Interface

LBMemAddr(11:0)	O	12	140-141, 144-145, 84-85, 88-93	Localbuffer Address bus.
LBMemRasN(1:0)	O	12	109, 113	Localbuffer DRAM RAS control lines.
LBMemCasN(5:0)	O	12	110-111, 112, 116-118	Localbuffer DRAM CAS control lines. These lines are used as byte enables for localbuffer accesses
LBMemOeN(1:0)	O	12	158-159	Localbuffer DRAM Output Enable Lines. These lines Select between 2 banks of memory for reads. For 1 bank only LBMemOEN(0) is used.
LBMemWeN(1:0)	O	12	162-163	Localbuffer DRAM Write Enable Lines. These lines are used to select between 2 banks of memory for writes. For 1 bank only LBMemWEN(0) is used.
LBMemData(47:0)	I/O	12	77-80, 82-83, 95- 101, 104-108, 122-125, 128-133, 136-139, 146-157, 164-167	Localbuffer Data Bus. Also used at reset time to initialize internal registers. LBMemData(47:0) are also used as Data(7:0) for External Video/LUT-DAC and Expansion Rom. LBMemData(39:24) are also used as Address(15:0) for External Video and Expansion ROM.

Framebuffer Interface

FBMemAddr(8:0)	O	12	217-219, 222, 224-228	Framebuffer Address Bus.
FBMemRasN(3:0)	O	12	264-265, 259-260	Framebuffer VRAM RAS control lines.
FBMemCasN(7:0)	O	12	186-189, 192-195	Framebuffer VRAM CAS control lines.
FBMemOeN(3:0)	O	12	253, 256-258	Framebuffer VRAM Output Enable lines.
FBMemWeN(3:0)	O	12	249-252	Framebuffer VRAM Write Enable lines.
FBMemDSF(1:0)	O	12	269, 271	Framebuffer VRAM DSF lines. These lines are electrically the same. Two DSF lines are provided for buffering purposes. NB. These DSF lines do NOT equate to the DSF0 and DSF1 lines of hyperpipelined VRAMs such as Toshiba TC528267

Symbol	Type	Power	Pin Number(s)	Description
FBMemData(63:0)	I/O	12	170-175, 178-182, 184-185, 196-203, 206-211, 213-216, 229-237, 240-245, 248, 272-277, 280-286, 288-291	Framebuffer Data Bus.
FBGnt	I/O	8	4	Shared Framebuffer grant. This line is an output when GLINT 300SX is a shared framebuffer primary controller. This line is an input when a secondary controller.
FBSelOE/SOE2	I/O	8	2	When TX Enhanced function pin is pulled high, this pin is VRAM serial output Enable 2, otherwise it is the Shared Framebuffer output enable which can be used to control memory control signal buffers when a secondary shared framebuffer controller.

Video Control

VClkCtl(1:0)	O	8	70-71	Pixel clock select lines. Can be used to control multi-rate Pixel clock generation chips.
HSync/ExtTxCmd1	O	8	292	Video Horizontal Sync line / Controls the external transfer address generator and acknowledges an ExtTxReq
VSync/ExtTxCmd0	O	8	293	Video Vertical Sync line / Controls the external transfer address generator and acknowledges an ExtTxReq
QSF/ExtTxReq	I		297	Input from VRAM QSF pin or External Timing generator to control VRAM transfer cycles
CBlank/ExtTxSplit	I/O	8	298	Video Composite Blank line / Qualifies ExtTxReq as a split transfer (instead of full transfer)
CompSync	O	8	1	Video Composite Sync line.
DacWrN	O	8	120	LUT-DAC / External VideoWrite line.
DacRdN	O	8	121	LUT-DAC / External VideoRead line.
SClk(1:0)	O	12	299, 301	Video serial clocks.
SOE(1:0)	O	12	302-303	Video serial output enable.
SOE3	O	12	46	When the TX Enhanced function pin is pulled high, this pin is VRAM serial output enable 3, otherwise the pin is tri-state.

Symbol	Type	Power	Pin Number(s)	Description
--------	------	-------	---------------	-------------

Misc.

TXEnhanced	I		270	TX Enhanced Function pin. When this pin is pulled low, the GLINT 500TX pin functionality remains consistent with GLINT 300 SX. When this pin is pulled high, the SOE2 and SOE3 functionality is enabled. The new shared Localbuffer/Framebuffer functionality and S3 compatible framebuffer modes are enabled.
PCIRstN	I		10	Power On and Hardware reset.
ExtIntN	I		223	Ext Interrupt Internal Pullup
RomEnN	O	8	119	Expansion ROM enable
TestMode	I		263	Test mode control.
TestAClk	I		6	Test clock A. Internal Pulldown
TestBClk	I		7	Test clock B. Internal Pulldown
TestCClk	I		268	Test clock C. Internal Pulldown
DI1	I		58	Test Driver Inhibit. This pin must be pulled high in functional mode.
DI2	I		134	Test Driver Inhibit. This pin must be pulled high in functional mode.
VDD	I		8, 24, 38, 52, 68, 86, 102, 114, 126, 142, 160, 168, 176, 190, 204, 220, 238, 246, 254, 266, 278, 294	Vdd pins. All must be used
GND	I		9, 16, 25, 29, 33, 39, 45, 53, 63, 69, 72, 81, 87, 94, 103, 115, 127, 135, 143, 161, 169, 177, 183, 191, 205, 212, 221, 239, 247, 255, 261, 267, 279, 287, 295, 300	Ground pins. All must be used.

10.3 Pin Lists

Table 10-2. Alphabetical Pin Listing

Symbol	Pin Numbers
CBlank/ExtTxSplit	298
CompSync	1
DacRdN	121
DacWrN	120
DI1	58
DI2	134
ExtIntN	223
FBGntN	4
FBMemAddr(8:0)	217-219, 222, 224-228
FBMemCasN(7:0)	186-189, 192-195
FBMemData(63:0)	170-175, 178-182, 184-185, 196-203, 206-211, 213-216, 229-237, 240-245, 248, 272-277, 280-286, 288-291
FBMemDSF(1:0)	269, 271
FBMemOeN(3:0)	253, 256-258
FBMemRasN(3:0)	264-265, 259-260
FBMemWeN(3:0)	249-252
FBReqN	3
FBSelOEN/SOE2	2
GND	9, 16, 25, 29, 33, 39, 45, 53, 63, 69, 72, 81, 87, 94, 103, 115, 127, 135, 143, 161, 169, 177, 183, 191, 205, 212, 221, 239, 247, 255, 261, 267, 279, 287, 295, 300
HSync/ExtTxCmd1	292
LBMemAddr(11:0)	140-141, 144-145, 84-85, 88-93
LBMemCasN(5:0)	110-111, 112, 116-118
LBMemData(47:0)	77-80, 82-83, 95-101, 104-108, 122-125, 128-133, 136-139, 146-157, 164-167
LBMemOeN(1:0)	158-159
LBMemRasN(1:0)	109, 113
LBMemWeN	162-163
LDClk	304
MClk	262
PCIAD(31:0)	14-15, 17-22, 27-28, 30-32, 34-36, 51, 54-57, 59-61, 64-67, 73-76
PCICBEN(3:0)	23, 37, 50, 62
PCIClk	11
PCIDevselN	43
PCIFifoInDis	47
PCIFifoOutDis	48
PCIFrameN	40
PCIGntN	12
PCIIdsel	26
PCIIntAN	5
PCIIRdyN	41

Table 10-2. Alphabetical Pin Listing (Continued)

Symbol	Pin Numbers
PCIPar	49
PCIPerrN	47
PCIReqN	13
PCIRstN	10
PCISerrN	48
PCIStopN	44
PCITRdyN	42
VClkCtl(1:0)	70-71
QSF/ExtTxReq	297
RomEnN	119
SCLK(1:0)	299, 301
SOE(1:0)	302-303
SOE3	46
TestAClk	6
TestBClk	7
TestCCLK	268
TestMode	263
TXEnhanced	270
VClk	296
VDD	8, 24, 38, 52, 68, 86, 102, 114, 126, 142, 160, 168, 176, 190, 204, 220, 238, 246, 254, 266, 278, 294
VSynC/ExtTxCmd0	293

Table 10-3. Numerical Pin Listing

Pin	Name
1	CompSync
2	FBSelOEN/SOE2
3	FBReqN
4	FBGntN
5	PCIIntAN
6	TestAClk
7	TestBClk
8	VDD
9	GND
10	PCIRstN
11	PCIClk
12	PCIGntN
13	PCIReqN
14	PCIAD31
15	PCIAD30
16	GND
17	PCIAD29
18	PCIAD28
19	PCIAD27
20	PCIAD26
21	PCIAD25
22	PCIAD24
23	PCICBEN3
24	VDD
25	GND
26	PCIIdsel
27	PCIAD23
28	PCIAD22
29	GND
30	PCIAD21
31	PCIAD20
32	PCIAD19
33	GND
34	PCIAD18
35	PCIAD17
36	PCIAD16
37	PCICBEN2
38	VDD

Pin	Name
39	GND
40	PCIFrameN
41	PCIIRdyN
42	PCITRdyN
43	PCIDevselN
44	PCIStopN
45	GND
46	SOE3
47	PCIFifoInDis
48	PCIFifoOutDis
49	PCIPar
50	PCICBEN1
51	PCIAD15
52	VDD
53	GND
54	PCIAD14
55	PCIAD13
56	PCIAD12
57	PCIAD11
58	DI1
59	PCIAD10
60	PCIAD9
61	PCIAD8
62	PCICBEN0
63	GND
64	PCIAD7
65	PCIAD6
66	PCIAD5
67	PCIAD4
68	VDD
69	GND
70	VClkCtl1
71	VClkCtl0
72	GND
73	PCIAD3
74	PCIAD2
75	PCIAD1
76	PCIAD0

Table 10-3. Numerical Pin Listing (Continued)

Pin	Name
77	LBMemData47
78	LBMemData46
79	LBMemData45
80	LBMemData44
81	GND
82	LBMemData43
83	LBMemData42
84	LBMemAddr7
85	LBMemAddr6
86	VDD
87	GND
88	LBMemAddr5
89	LBMemAddr4
90	LBMemAddr3
91	LBMemAddr2
92	LBMemAddr1
93	LBMemAddr0
94	GND
95	LBMemData41
96	LBMemData40
97	LBMemData39
98	LBMemData38
99	LBMemData37
100	LBMemData36
101	LBMemData35
102	VDD
103	GND
104	LBMemData34
105	LBMemData33
106	LBMemData32
107	LBMemData31
108	LBMemData30
109	LBMemRasN1
110	LBMemCasN5
111	LBMemCasN4
112	LBMemCasN3
113	LBMemRasN0
114	VDD

Pin	Name
115	GND
116	LBMemCasN2
117	LBMemCasN1
118	LBMemCasN0
119	RomEnN
120	DacWrN
121	DacRdN
122	LBMemData29
123	LBMemData28
124	LBMemData27
125	LBMemData26
126	VDD
127	GND
128	LBMemData25
129	LBMemData24
130	LBMemData23
131	LBMemData22
132	LBMemData21
133	LBMemData20
134	DI2
135	GND
136	LBMemData19
137	LBMemData18
138	LBMemData17
139	LBMemData16
140	LBMemAddr11
141	LBMemAddr10
142	VDD
143	GND
144	LBMemAddr9
145	LBMemAddr8
146	LBMemData15
147	LBMemData14
148	LBMemData13
149	LBMemData12
150	LBMemData11
151	LBMemData10
152	LBMemData9

Table 10-3 Numerical Pin Listing (Continued)

Pin	Name
153	LBMemData8
154	LBMemData7
155	LBMemData6
156	LBMemData5
157	LBMemData4
158	LBMemOeN1
159	LBMemOeN0
160	VDD
161	GND
162	LBMemWeN1
163	LBMemWeN0
164	LBMemData3
165	LBMemData2
166	LBMemData1
167	LBMemData0
168	VDD
169	GND
170	FBMemData63
171	FBMemData62
172	FBMemData61
173	FBMemData60
174	FBMemData59
175	FBMemData58
176	VDD
177	GND
178	FBMemData57
179	FBMemData56
180	FBMemData55
181	FBMemData54
182	FBMemData53
183	GND
184	FBMemData52
185	FBMemData51
186	FBMemCasN7
187	FBMemCasN6
188	FBMemCasN5
189	FBMemCasN4
190	VDD

Pin	Name
191	GND
192	FBMemCasN3
193	FBMemCasN2
194	FBMemCasN1
195	FBMemCasN0
196	FBMemData50
197	FBMemData49
198	FBMemData48
199	FBMemData47
200	FBMemData46
201	FBMemData45
202	FBMemData44
203	FBMemData43
204	VDD
205	GND
206	FBMemData42
207	FBMemData41
208	FBMemData40
209	FBMemData39
210	FBMemData38
211	FBMemData37
212	GND
213	FBMemData36
214	FBMemData35
215	FBMemData34
216	FBMemData33
217	FBMemAddr8
218	FBMemAddr7
219	FBMemAddr6
220	VDD
221	GND
222	FBMemAddr5
223	ExtIntN
224	FBMemAddr4
225	FBMemAddr3
226	FBMemAddr2
227	FBMemAddr1
228	FBMemAddr0

Table 10-3. Numerical Pin Listing (Continued)

Pin	Name
229	FBMemData32
230	FBMemData31
231	FBMemData30
232	FBMemData29
233	FBMemData28
234	FBMemData27
235	FBMemData26
236	FBMemData25
237	FBMemData24
238	VDD
239	GND
240	FBMemData23
241	FBMemData22
242	FBMemData21
243	FBMemData20
244	FBMemData19
245	FBMemData18
246	VDD
247	GND
248	FBMemData17
249	FBMemWeN3
250	FBMemWeN2
251	FBMemWeN1
252	FBMemWeN0
253	FBMemOeN3
254	VDD
255	GND
256	FBMemOeN2
257	FBMemOeN1
258	FBMemOeN0
259	FBMemRasN1
260	FBMemRasN0
261	GND
262	MClk
263	TestMode
264	FBMemRasN3
265	FBMemRasN2
266	VDD

Pin	Name
267	GND
268	TestCclk
269	FBMemDSF1
270	TXEnhanced
271	FBMemDSF0
272	FBMemData16
273	FBMemData15
274	FBMemData14
275	FBMemData13
276	FBMemData12
277	FBMemData11
278	VDD
279	GND
280	FBMemData10
281	FBMemData9
282	FBMemData8
283	FBMemData7
284	FBMemData6
285	FBMemData5
286	FBMemData4
287	GND
288	FBMemData3
289	FBMemData2
290	FBMemData1
291	FBMemData0
292	HSync/ExtTxCmd1
293	VSyn/ExtTxCmd0
294	VDD
295	GND
296	VClk
297	QSF/ExtTxReq
298	CBlank/ExtTxSplit
299	SClk1
300	GND
301	SClk0
302	SOE1
303	SOE0
304	LDClk

11. Thermal Management

The maximum junction temperature must be kept below $T_j(\text{max})$ and this can only be guaranteed by proper analysis of the operating environment and the thermal path between the die and the air surrounding it.

11.1 Device Characteristics

These are fixed characteristics of the device and are independent of the operating environment or the characteristics of any heatsink:-

$$T_j(\text{max}) = 100 \text{ }^\circ\text{C}.$$

$$P_d(\text{max}) = 3.7 \text{ Watts @ } V_{dd}(\text{max}), f_{\text{MClk}} = 50\text{MHz}.$$

$$\theta_{jc} = 0 \text{ }^\circ\text{C/Watt}.$$

(there is no case to consider here, so this resistance is negligible)

11.2 Thermal Model

The formula used to calculate the junction temperature (T_j) is

$$\begin{aligned} T_j &= T_a + P_d \times (\theta_{jc} + \theta_{cs} + \theta_{sa}) \\ &= T_a + P_d \times \theta_{ja} \end{aligned}$$

Where:-

T_j	=	Junction temperature ($^\circ\text{C}$)
T_a	=	Ambient temperature ($^\circ\text{C}$)
P_d	=	Power dissipation (Watts)
θ_{jc}	=	Junction to Case thermal resistance ($^\circ\text{C/Watt}$)
θ_{cs}	=	Case to Heatsink thermal resistance ($^\circ\text{C/Watt}$)
θ_{sa}	=	Heatsink to Air thermal resistance ($^\circ\text{C/Watt}$)
θ_{ja}	=	Total Junction to Air thermal resistance ($^\circ\text{C/Watt}$)

The θ_{ja} form of the equation is more appropriate when there is no heatsink attached to the device (see below).

11.3 Operation Without Heatsink

Generally it is not recommended that this device is operated without a heatsink due to the high airflow rates which must be maintained to keep T_j below $T_j(\text{max})$.

The 304 CQFP package with the die exposed on the top surface and no attached heatsink has the following θ_{ja} characteristic as a function of airflow:-

Table 11-1. 304 pin CQFP Package Thermal Characteristics

Airflow (lfpm)	θ_{ja} ($^{\circ}$ C/W)
0 (Convection Cooling)	30
50 (0.25m/sec)	26
100 (0.5m/sec)	23
200 (1m/sec)	20
400 (2m/sec)	18

Example:-

$$T_a = 30^{\circ} \text{C}$$

$$\text{Airflow} = 400 \text{ lfpm}$$

$$T_j = 30 + 3.7 \times (18)$$

$$= 96.6^{\circ} \text{C}$$

11.4 Operation With Heatsink

With a heatsink attached to the device the junction temperature will depend on θ_{CS} and θ_{SA} . θ_{CS} is the thermal resistance of the join between the heatsink and the exposed back surface of the die. θ_{SA} is the thermal resistance of the heatsink and will be a function of system airflow.

Example:-

$$T_a = 40^{\circ} \text{C}$$

$$\theta_{CS} = 1.0^{\circ} \text{C/Watt} \quad (\text{EG 7655 epoxy - see below})$$

$$\theta_{SA} \leq (100 - 40)/3.7 - 1.0$$

$$\leq 15.2^{\circ} \text{C/Watt.}$$

In this example a heatsink must be chosen which has a thermal resistance figure of no greater than $15.2^{\circ} \text{C/Watt}$ at an airflow matching the expected airflow in the system.

11.5 Heatsink Attachment

Two methods have been approved for the purpose of attaching a heatsink directly onto the exposed die surface and the Urethane conformal coating material covering the top of the CQFP package.

11.5.1 Preferred Attachment Method

Thermally conductive epoxy. Either Loctite Output 315 with Loctite 7387 or type EG 7655 from A.I. Technology Inc. The thickness of the epoxy layer should be between 0.05mm and 0.15mm with 100% coverage of the exposed die area, and a maximum voiding in the bond area of 3%. This epoxy should not be used outside the die area.

Typical achievable θ_{CS} using this method is 1.0 ° C/Watt.

11.5.2 Alternative Attachment Method

Chomerics Thermattach 405 thermally conductive tape when used with an additional adhesive, such as Loctite Output 315, for structural support outside the die area.

Typical achievable θ_{CS} using this method is 2.2 ° C/Watt.

12. Reset Control and Test Mode

12.1 Reset

A number of parameters for the GLINT 500TX are set at reset , such as Localbuffer and Framebuffer memory size and speed. The reset state is configured with resistors connected to the Localbuffer data pins. The state of the data pins is sampled on the rising edge of the reset line. Various parameters may be configured e.g.

- Framebuffer and Localbuffer sizes.
- Framebuffer and Localbuffer RAS and CAS timings
- Framebuffer and Localbuffer widths.

To set a bit to 1 the relevant data pin should be tied to VDD (3.3V) with a 10K resistor.

To set a bit to 0 the relevant data pin should be tied to ground with a 4K7 resistor.

12.2 Clock Operation at Reset

The GLINT 500TX is a synchronous device. For correct reset operation the clocks must be running during the reset pulse. At power-up care must be taken to ensure that MClk and VClk are running before the system reset pulse completes.

12.3 Reset Localbuffer Configuration

This is determined as follows by the reset state of the Localbuffer data pins:

Bit 0	Number of Banks
	0 1 Bank
	1 2 Banks
Bits 2-1	Page Size
	0 256 Pixels
	1 512 Pixels
	2 1024 Pixels
	3 2048 Pixels
Bits 4-3	RAS-CAS low
	0 2 Clocks
	1 3 Clocks
	2 4 Clocks
	3 5 Clocks
Bits 6-5	RAS Precharge
	0 2 Clocks
	1 3 Clocks
	2 4 Clocks
	3 5 Clocks

Bits 8-7	CAS Low
	0 1 Clocks
	1 2 Clocks
	2 3 Clocks
	3 4 Clocks
Bit 9	Page Mode Disable
	0 Page mode Enabled
	1 Page mode Disabled
Bit 18	Dual Write Enables
	0 2 WE and 6 CAS pins
	1 6 WE and 2 CAS pins
Bits 21-20	PCI Maximum Latency
	Forms the top 2 bits of the configuration space Maximum Latency register
Bits 23-22	PCI Minimum Grant
	Forms the top 2 bits of the configuration space Minimum Grant register
Bits 26-24	Localbuffer Visible Region Size
	0 1 Mbyte
	1 2 Mbytes
	2 4 Mbytes
	3 8 Mbytes
	4 16 Mbytes
	5 32 Mbytes
	6 64 Mbytes
	7 0 Mbytes
Bits 29-27	Localbuffer width
	0 16 bits
	1 18 bits
	2 24 bits
	3 32 bits
	4 36 bits
	5 40 bits
	6 48 bits
	7 Other width
Bit 30	Localbuffer Bypass Packing
	0 64 bit Localbuffer bypass step
	1 32 bit Localbuffer bypass step
Bit 31	Aperture 1 Enable
	0 Aperture 1 disabled
	1 Aperture 1 enabled

12.4 Reset Framebuffer Configuration

This is determined as follows by the reset state of the Framebuffer data lines:

Bits 1-0	RAS-CAS low
0	2 Clocks
1	3 Clocks
2	4 Clocks
3	5 Clocks
Bits 3-2	RAS Precharge
0	2 Clocks
1	3 Clocks
2	4 Clocks
3	5 Clocks
Bits 5-4	CAS Low
0	1 Clocks
1	2 Clocks
2	3 Clocks
3	4 Clocks
Bit 6	Page Mode Disable
0	Page mode Enabled
1	Page mode Disabled
Bit 10	Fast Mode Disable
0	Enabled
1	Disabled
Bits 12-11	Shared Framebuffer Mode
0	Disabled
1	Arbiter
2	Requester
3	Reserved
Bit 13	Video Transfer Disable
0	Transfer Cycles Enabled
1	Transfer Cycles Disabled

Bit 14 External VTG Select

- 0 Internal VTG
- 1 External VTG

Bits 16-15 Framebuffer Interleave

- 0 1 way
- 1 2 way
- 2 4 way
- 3 Reserved

Bits 18-17 Block Fill Size

- 0 Disabled
- 1 4 Pixels
- 2 8 Pixels
- 3 Reserved

Bit 19 Dual Write Enables

- 0 4 WE and 8 CAS pins
- 1 8 WE and 4 CAS pins

Bit 20 TX Enhanced Shared Memory

- 0 GLINT 300SX compatible Shared Framebuffer control
- 1 Enhanced Shared Memory Control

Bit 21 SFBModeSwap

- 0 SFBMode field has default action
- 1 invert action of SFBMode field

Bit 22 EDO DRAM Localbuffer

- 0 Fast Page Mode DRAM fitted for Local buffer
- 1 EDO Dram fitted for Local Buffer

(This field has no direct effect on the hardware)

Bit 26 Base Class Zero

- 0 = GLINT 500TX returns a PCI Base class and sub-class of 03h 80h
- 1 = GLINT 500 TX returns a PCI Base Class and sub-Class of 00h 00h

Bit 27 Reserved

Bit 28 Aperture 1 Enable

- 0 Aperture 1 disabled
- 1 Aperture 1 enabled

Bits 31-29 Framebuffer Visible Region Size

0	1 Mbyte
1	2 Mbytes
2	4 Mbytes
3	8 Mbytes
4	16 Mbytes
5	32 Mbytes
6	Reserved
7	0 Mbytes

12.5 Production Test Mode

This section describes how to place the GLINT 500TX into a mode suitable for board production test. In Board ATE mode, all GLINT drivers are tristated. In order to do this, the DI1 and DI2 pins must be pulled low.

Table 12-1. GLINT 500TX Functional Mode

Pin	
DI2	high
DI1	high
TestAClk	low
TestBCLK	low
TestCCLK	low

Table 12-2. GLINT 500TX Board ATE Mode

Pin	
DI1	low
DI2	low
TestAClk	low
TestBCLK	low
TestCCLK	low

13. Package Dimensions

Figure 13-1 Mechanical Diagrams

Table 13-1. 304 pin CQFP Package Dimensions

Dimension		mm
a	Lead Pitch	0.5
b	Lead Width	0.23 ± 0.05
c	Foot Length	0.5 ± 0.1
d	Height	3.1 max
E	Width (toe to toe)	42.6 ± 0.2
F	Body Width	40.0 ± 0.2

App. A GLINT 300SX and 500TX Hardware Differences

The GLINT 500TX has been designed to be backwards compatible with GLINT 300SX. In general, a GLINT 500TX may be placed directly on a board designed for a GLINT 300SX without modification to the board. However there are some additional features in GLINT 500TX which, if used, may require a different board layout. These features are only enabled if a pin, which was assigned to GND on the GLINT 300SX, is pulled high. The additional features are described below.

A.1 Localbuffer

The GLINT 500TX supports the use of EDO DRAM for the localbuffer. No board design changes are necessary to use EDO DRAM in place of Fast Page mode DRAM. There is an internal register which is used to select between the different memory types.

The GLINT 500TX supports a Shared Localbuffer protocol similar to the Shared Framebuffer protocol. The Shared Localbuffer capability is enabled at reset using a configuration resistor on the framebuffer data bus. In order to avoid problems of backwards compatibility with the GLINT 300SX, this configuration resistor is ignored unless the TX Enhanced Function pin is pulled high (see pinout section).

When the TX Enhanced Function pin is pulled high, then the reset state of bits 21 and 20 of the framebuffer data bus is used in conjunction with the reset state of bit 12-11 of the framebuffer data bus to determine how the Shared Framebuffer and Localbuffer interfaces are configured. The options are as follows:-

Table A-1. Shared Framebuffer and Localbuffer Options

SFBSwap	TXEnhanced Shared Memory	SFB Mode Bits	Framebuffer Configuration	Localbuffer Configuration
X	0	0	Not Shared	Not Shared
0	0	1	Primary Controller	Not Shared
0	0	2	Secondary Controller	Not Shared
X	0	3	Secondary Controller	Secondary Controller
X	1	0	Not Shared	Not Shared
0	1	1	Not Shared	Primary Controller
0	1	2	Not Shared	Secondary Controller
X	1	3	Primary Controller	Primary Controller
1	0	1	Secondary Controller	Not Shared
1	0	2	Primary Controller	Not Shared
1	1	1	Not Shared	Secondary Controller
1	1	2	Not Shared	Primary Controller

Primary Controller and Secondary Controller refer to the function of the GLINT 500TX.

N.B. There is one request line and one grant line for both localbuffer and framebuffer. If both the Shared Framebuffer and Shared Localbuffer capabilities are enabled simultaneously, then control is passed together for both memory interfaces from primary to secondary controller.

A.2 Framebuffer

The GLINT 500TX only supports a 64 bit data bus width into the framebuffer. A 32 bit data bus into the framebuffer is not supported.

The GLINT 500TX provides two new framebuffer configurations in order to be compatible with S3 devices when the Shared Framebuffer interface is used. These new configurations remove the need to perform the GLINT 300SX workarounds described in Design Alerts 106.1.24.1 and 106.1.27.1. The new configurations are only available if the TX Enhanced Function pin is pulled high.

A.3 Internal Video Timing Generator

The GLINT 500TX provides two additional framebuffer Serial Output enable pins - SOE2 and SOE3. These extra pins enable the internal video timing generator to display 4 x 64 bit interleaved framebuffer banks with a 64 bit LUT-DAC. (The GLINT 300SX is only able to display 2 x 64 bit interleaved framebuffer banks with a 64 bit LUT-DAC or 4 x 64 bit interleaved framebuffer banks with a 128 bit LUT-DAC).

SOE2 is output on the FBSeIOEN pin when the GLINT 500TX is not used as a Shared Framebuffer secondary controller. When the GLINT 500TX is a Shared Framebuffer secondary controller, it cannot be used to control the video display. Hence SOE2 is not required and FBSeIOEN reverts to its original function.

SOE3 is output on the PCILockN pin when the TX Enhanced Function pin is pulled high. The GLINT 500TX does not use or drive the PCILockN signal and this pin does not need to be connected to the PCI bus. If the TX Enhanced Function pin is pulled low, then PCILockN is tri-stated and may be connected to the PCI bus.

A.4 Pinout

The following pins have extended functionality on the GLINT 500TX:

Table A-2. Extended Pin Functionality

Pin No.	Pin Name	GLINT 300SX Function	GLINT 500TX Function
2	FBSelOEN/SOE2	FBSelOEN	FBSelOEN when TX Enhanced Function is pulled low. SOE2 when TX Enhanced Function is pulled high.
46	PCILockN/SOE3	PCI Lock signal	Tri-state when TX Enhanced Function is pulled low. SOE3 when TX Enhanced Function is pulled high.
58	DI1	VDD	Test pin - Pulled high in functional mode
134	DI2	VDD	Test pin - Pulled high in functional mode
270	GND/TXEnhance	GND	TX Enhanced Function. If pulled high, then the GLINT 500TX enhanced functions are enabled.

N.B. A pin should be pulled high by connecting to +5V via a 10K resistor. A pin should be pulled low by connecting to ground via a 10K resistor.

Index

Address Map	iv, v, viii, 4, 17, 67, 71	CFGHeaderType	7, 80
Alpha blend.....	25	CFGIntLine.....	12, 80
alpha blending.....	1	CFGIntPin	80
Alpha test.....	25	CFGLatTimer.....	10, 80
antialiasing	1	CFGMaxLat	11, 80
Aperture 0 Control Register.....	26	CFGMinGrant	11, 80
Aperture 1 Control Register.....	28	CFGRevisionId.....	6
Aperture0.....	26, 81	CFGRomAddr	15
Aperture1.....	28, 81	CFGStatus.....	9, 80
Back Porch.....	62	CFGVendorId	6, 80
Base	iv, 7, 12, 13, 14, 15, 36, 80, 122	Class Code Register	7
Base Address 0 Register.....	12	clock speeds	3
Base Address 1 Register.....	13	Color DDA	25
Base Address 2 Register.....	13	Command Register.....	8
Base Address 3 Register.....	14	CompositeBlank.....	44
Base Address 4 Register.....	14	CompositeSync	44
BIST.....	10, 80	CompSync.....	49, 56, 91, 108, 110, 112
Blanking Time	62, 63	configuration registers	2, 5
Cache Line Size.....	10	configuration space.....	2, 32, 120
CBlank	49, 56, 78, 88, 91, 108, 110, 115	depth buffering	1
CFGBaseAddr0	12, 80	Device Control	iv, 8, 80
CFGBaseAddr1	13, 80	Device ID.....	6
CFGBaseAddr2	13	Device Status	iv, 9
CFGBaseAddr3	14	DMA Control Register.....	29
CFGBaseAddr4.....	14	DMA controller	2, 21, 22, 29, 43
CFGBist	10, 80	DMA Count.....	22
CFGCacheLine	80	DMA Flag	20
CFGClassCode	7, 80	DMA Start Address.....	22
CFGCommand.....	8, 80	DMAAddress.....	22, 81
CFGDeviceId.....	6	DMAControl.....	29, 81

DMACount.....	22, 81	Fog.....	25
Dot Clock.....	62, 63	Frame Row Address register.....	50, 56
DRAM.....	vi, 2, 3, 31, 32, 34, 36, 66, 68, 99, 102, 107, 122, 126	Framebuffer..	iv, v, vi, vii, viii, 2, 3, 4, 13, 14, 17, 26, 28, 35, 36, 37, 38, 39, 40, 41, 44, 69, 70, 71, 72, 73, 74, 75, 76, 78, 79, 81, 88, 92, 93, 94, 107, 108, 109, 119, 121, 122, 123, 126, 127
EDO DRAM.....	34, 36, 67, 68, 122, 126	Configurations.....	v, vi, 70, 78
Electrical Data		PCI Region 2 and Region 4 Address Map..	v, 71
AC Specifications.....	v, 84	Pixel Packing.....	vi, 71
DC Specifications.....	v, vi, 83, 84	Registers.....	iv, 17, 35, 81
Non PCI Signal DC Specifications.....	vi, 84	Shared.....	v, 73
PCI Signal DC Specifications.....	vi, 83, 84	Timing.....	v, vi, 76, 94
Electrical Ratings.....	v, vi, 83	Visible Bypass Memory.....	vi, 71
EPROM.....	iv	Framebuffer Bypass Write Mask.....	41
Error Flag.....	20, 23	Framebuffer Graphics Core Color Lower...	39
Error Flags Register.....	23	Framebuffer Graphics Core Color Upper...	41
ErrorFlags.....	23, 81	Framebuffer Graphics Core Write Mask....	39
Expansion EPROM.....	iv	Framebuffer Memory Control.....	35
Expansion ROM Base Address.....	15	Framebuffer Memory Interface.....	iv, 3
Expansion ROM Interface.....	iv, 16	Framebuffer Mode Select.....	37
External Flag.....	20	Framebuffer Registers.....	iv, 17, 35, 81
External Timing Generator..	v, viii, 76, 77, 78	Framebuffer TX Shared Memory Control.	40, 75, 81
External Video Logic Interface.....	iv	Frequency.....	4, 62
FBGCCColorLower.....	81	Front Porch.....	63
FBGCWrMask.....	39, 81	Functional Overview.....	iv, 1
FBMemCasN.....	38, 89, 107, 110	GID Stencil Depth.....	25
FBMemoryCtl.....	35, 81	GLINT 500TX	
FBMemWeN.....	38, 79, 84, 89, 107, 110	Base Addresses.....	iv, 80
FBModeSel.....	37, 40, 61, 73, 81	Device Control/Status.....	80
FBTXMemCtl.....	40, 73, 81	Device Identification.....	iv, 6, 80
FBWrMaskk.....	41	Miscellaneous Functions.....	iv, 10, 80
FIFO.....	iv, 2, 17, 21, 23, 30, 43, 81		
FIFO Disconnect Register.....	30		
FIFODis.....	30, 81		

Register Set	v, 80	Interrupt Enable Register.....	19
GLINT 500TX as Secondary Controller.....	75	Interrupt Flags Register	20
Gouraud shading.....	1	Interrupt Line	12
Graphics Core.....	iv, 2, 3, 17, 18, 22, 39, 41, 42, 43, 52, 71	Interrupt Pin.....	11
Graphics Core FIFO Interface	iv, 43	IntFlags.....	20, 81
Graphics Core Registers.....	iv, 42	Introduction	iv, 1
HBlank.....	56	Latency Timer	10
Header Type.....	7	LB read.....	25
Heatsink	v, 116, 117, 118	LB write	25
Alternative Attachment Method	118	LBMemCasN	32, 69, 89, 107, 110
Attachment	v, 118	LBMemoryCtl	31, 68, 81
Preferred Attachment Method.....	118	LBMemoryCtl register.....	68
hexadecimal number.....	1, 2	LBMemoryEDO.....	34, 68, 81
HGate.....	47, 56	LBMemWeN.....	32, 84, 89, 107, 110
Horizontal Blank End.....	46	Localbuffer ...	iv, v, vi, vii, viii, 2, 3, 4, 11, 13, 14, 16, 17, 26, 28, 31, 32, 33, 34, 35, 36, 37, 64, 66, 67, 68, 69, 73, 81, 96, 97, 98, 99, 100, 101, 102, 107, 109, 119, 120, 122, 126
Horizontal Gate	47, 48, 56	BankSize	68
Horizontal Gate End	48	Example Configuration.....	v, 69
Horizontal Gate Start	47	Field Sizes	vi, 67
Horizontal Limit	45	Memory Types.....	v, 67
Horizontal Sync End	45	Registers	iv, 17, 31, 81
Horizontal Sync Start Register.....	45	Shared	iv, v, 3, 69, 126
Horizontal Timing Specifications.....	54	Visible Bypass Memory.....	vi, 67
HSync...44, 49, 56, 78, 89, 91, 108, 110, 115		Localbuffer data pins.....	4, 11, 13, 14, 31, 35, 37, 64, 67, 119
InFIFOspace	21, 43, 81	Localbuffer Memory Control.....	31
Input FIFO Error Flag.....	23	Localbuffer Memory EDO	34
Input FIFO Space Register	21	Localbuffer Memory Interface	iv, 2
IntEnable	19, 81	Localbuffer Registers	iv, 17, 31, 81
Interleave	viii, 58, 60, 61, 70	Maximum Latency.....	11, 32, 120
Internal Video Registers.....	17, 82		
Internal Video Timing Generator...iv, 44, 127			
Internal VTG Register Set	45		

MClk...	vi, viii, 32, 40, 44, 65, 75, 77, 85, 88, 89, 106, 110, 115, 116, 119	Revision ID	6
Minimum Grant	11, 32, 120	scaleable memory architecture.....	1
Miscellaneous Functions.....	iv, 10, 80	Scissor Stipple	25
Mode Control.....	52, 82	SCLk.....	51, 52, 56, 57, 91, 108, 111
OutFIFOWords.....	21, 81	SCLks.....	56
Output FIFO Error Flag.....	23	secondary controller	3, 40, 73, 74, 75, 76, 108, 127
Output FIFO Words Register.....	21	Serial Clock Control.....	51, 56, 58
Overview of Internal VTG features	iv, 44	Serial Port Options.....	vi, 57
PCI apertures	2	SFBModeSwap.....	37, 40, 73, 122
PCI Configuration	iv, 5	Shared Localbuffer Interface	iv, 3
PCI interface.....	2, 10, 18, 44	Signals	
PCI Local Bus	2, 3	Primary Controller	vi, 74
PCIClk .	vi, viii, 44, 85, 86, 87, 106, 110, 112	Secondary Controller.....	vi, 74
PCIFrameN	1, 84, 86, 87, 106, 110, 112	Slave Hadjust	53
Period.....	62, 63	split register	50, 51, 56
Pin Information	v, 105	Status Register.....	9, 17, 18, 81
Pixel Clock Support.....	vi, 4	Sync and Blank Generation.....	56
Polarity Control	49, 56	Sync Flag	20
primary controller.....	3, 40, 73, 74, 75, 108	Sync Width.....	62
QSF.....	51, 52, 56, 78, 88, 90, 108, 111, 115	Sync. Polarity.....	62
RAMDAC	viii, 44, 56, 57, 58, 59, 61	Test Mode	v, 119, 124
Rasterizer	25	Test Register	25
Region 0 Address Map.....	iv, viii, 17	TestRegister	25, 81
Reset		texture mapping.....	1
Clock Operation.....	119	Thermal	
Framebuffer Configuration.....	121	Management.....	v, 116
Localbuffer Configuration.....	119	Model.....	v, 116
Reset Configuration Control.....	iv	Timing Generator Pins.....	vi, 78
Reset Control	v, 4, 18, 31, 35, 37, 67, 71, 119	Transfer Request Protocol	viii, 78
Reset Status Register	18	TXEnhanced	40, 53, 58, 73, 74, 75, 109, 111, 115, 126
ResetStatus.....	18, 81	undefined hexadecimal number	2

VBlank	56	VRAM Transfer Control	56
VClk vi, viii, 3, 44, 45, 46, 52, 53, 54, 82, 85, 90, 91, 106, 111, 115, 119		VRAM.	3, 35, 37, 38
VClkCtl.....	24, 81, 108, 111	VSync... 44, 49, 56, 78, 89, 91, 108, 111, 115	
VClkPeriod.....	54, 55, 56	VTG	iv, 38, 44, 45, 52, 54, 62, 78, 122
Vendor ID	6	VTG Configuration	54
Vertical and Horizontal Gate	56	VTGFrameRowAddr.....	50, 82
Vertical Blank End	47, 50	VTGHBlankEnd.....	46, 54, 63, 82
Vertical Gate.....	48	VTGHCount.....	54
Vertical Gate Start.....	48	VTGHGateEnd	48, 56, 63, 82
Vertical Limit.....	46	VTGHGateStart	56, 63, 82
Vertical Line Number.....	50	VTGHLimit	45, 54, 55, 63, 82
Vertical Sync End.....	47	VTGHSyncEnd	54, 63, 82
Vertical Sync Start.....	46	VTGHSyncStart	45, 54, 63, 82
Vertical Timing.....	viii, 55	VTGModeCtl.....	52, 82
VGate.....	56	VTGPolarity	49, 82
video clock.....	3, 4, 24, 44	VTGSerialClk.....	51, 82
Video Clock Control Register	24	VTGVBlankEnd	47, 55, 63, 82
Video Signals		VTGVGateEnd.....	56, 82
External	vi, 64	VTGVGateStart.....	48, 56, 82
Video Timing Generation.....	iv, 3	VTGVLimit.....	46, 55, 63, 82
VRAM Requirements.....	v, 76	VTGVLineNumber	82
VRAM Serial Port	57	VTGVSyncEnd.....	47, 55, 63, 82
		VTGVSyncStart.....	55, 63, 82